

Chapter 4: STA Performance, Compliance and Optimization

Gary Goforth, Kathleen Pietro, Michael Chimney, Jana Newman,
Tim Bechtel, Guy Germain and Nenad Iricanin

SUMMARY

As of June 2004, over 35,000 acres of Stormwater Treatment Areas (STAs) have been constructed by the South Florida Water Management District (District or SFWMD) (**Figure 4-1**). Almost 30,000 acres were in flow-through operation and removing total phosphorus (TP) that otherwise would have gone into the Everglades Protection Area (EPA). During Water Year 2004 (WY2004) (May 1, 2003 through April 30, 2004), Stormwater Treatment Areas 1 West, 2, 3/4, 5, and 6 Section 1 (STA-1W, STA-2, STA-3/4, STA-5, and STA-6) STA-1W, STA-2, STA-3/4, STA-5, and STA-6) treated more than 778,000 acre-feet (ac-ft) of water and removed more than 88 metric tons of TP. Inflow concentrations averaged 133 parts per billion (ppb), while the outflow concentrations averaged 41 ppb. This resulted in an overall 69-percent removal rate. STA performance varied, with outflow concentrations ranging from 12 to 14 ppb for STA-6 and STA-2, respectively, to almost 100 ppb for STA-5.

Since the initiation of STA operations in 1994 through the end of April 2004, the STAs have reduced the TP load by about 427 metric tons. A summary is provided in **Table 4-1**. The most significant milestone during this last reporting period was the completion of STA-3/4, the world's largest constructed wetland at over 16,500 acres. On January 15, 2004, the 6,500-acre Flow-way 1 of STA-3/4 passed the start-up requirements of the operating permits, and on February 25, 2004, the first discharges of treated water from this STA began. On June 7, 2004, the 3,500-acre Cell 3 began discharging. On September 16, 2004, the remaining 5,500 acre Flow-way 2 began discharging. The initial 12-month (October 1, 2003 to September 30, 2004) performance of STA-3/4 was exceptional, with over 445,000 ac-ft of water treated to an average outflow concentration of 14 ppb.

The SFWMD began the design and implementation of enhancements to STA-3/4, intended to further lower phosphorus levels. Key components include additional levees and water control structures, refined operations, and revisions to the vegetation communities, including a 400-acre demonstration Periphyton-Based Stormwater Treatment Area (PSTA) within the footprint of STA-3/4. These enhancements, along with enhancements to the other five STAs, will continue through the end of 2006. The construction of Stormwater Treatment Area 1 East (STA-1E) was substantially completed by the U.S. Army Corps of Engineers in June 2004. Initial flooding of STA-1E began in summer 2004. A 6-month to 18-month vegetation start-up period is anticipated before STA-1E is expected to discharge to the Arthur R. Marshall Loxahatchee National Wildlife Refuge, depending on growth of the vegetation.

The Everglades Protection Area Tributary Basins Long-Term Plan for Achieving Water Quality Goals (see Chapter 8 of the *2005 South Florida Environmental Report – Volume I*) recommends structural, vegetative and operational enhancements for each STA, and provides a

predicted range of long-term average outflow phosphorus concentrations once the enhancements are completed. Refinement of the operational strategies for the STAs is required to optimize their phosphorus removal performance and to ensure that they are not subject to overload from inflow volume or nutrients. In addition, assessment of annual or long-term performance is aided by a comparison of actual loading to the loading that was anticipated during the design of the treatment areas, and the subsequent design of the STA enhancements. A recent paper developed the “operational design envelope” for inflow volume and phosphorus loads that were anticipated for each STA (Goforth, 2004), and can be found on the District’s Website at http://www.sfwmd.gov/org/ema/toc/archives/docs/design_envelope_STA_051004.pdf.

As part of the adaptive implementation process envisioned by the District’s STA optimization program, it is anticipated that further refinements to the recommended water quality improvement measures would be made at the earliest achievable dates as more scientific and engineering information was obtained. Investigations are underway in each STA that are summarized in later sections of this report. General operational principles that are currently performed in the STA operations are as follows:

- Try to ensure inflows (flows and TP loads) are within the design envelope
- Avoid dryout and maintain a minimum of 15 cm depth
- Avoid keeping the water stage too deep for too long by limiting depth to a maximum of 137 cm for 10 days
- Maintain target depths between storm events:
 - Emergent: 38 cm
 - SAV: 45 cm
- Frequent field observations by site managers

A complete set of references regarding STA operations can be found online at http://www.sfwmd.gov/org/ema/everglades/consolidated_00/ecr2000/intro.pdf, and the 1995 Basis for Design paper is found online at <http://www.walker.net/pdf/stadesign.pdf>.

An overview of the STA operations, vegetation management, phosphorus performance, water quality monitoring, and permit compliance for each of the STAs is presented in this chapter. Water quality parameters that are addressed include nutrients, physical parameters including but not limited to pH, turbidity, dissolved oxygen (DO), pesticides, major ions, and mercury. This information documents compliance with appropriate conditions of the Everglades Forever Act and the U.S. Environmental Protection Agency’s National Pollution Discharge Elimination System permits. Water quality monitoring within and downstream of the treatment areas demonstrated that the five STAs in operation are in full compliance with state operating permits. A summary of STA operations and issues is presented in **Table 4-2**. Appendices presented with this chapter provide additional details of the monitoring program, as required by state operating permits.

Table 4-1. Stormwater Treatment Area (STA) hydrology and total phosphorus (TP) removal for Water Year 2004 (WY2004). Start-up operations started in October 2003 and flow-through began in February 2004 for STA-3/4.

	STA-1W	STA-2	STA-3/4	STA-5	STA-6	All STAs
Total Inflow Volume (ac-ft)	292,690	256,938	23,303	153,080	52,674	778,685
Hydraulic Loading Rate (cm/d)	3.7	3.3	0.3	3.1	5.1	3.4
Flow-weighted Mean Inflow TP (ppb)	141	77	49	255	53	133
TP Loading Rate (g/m ² /yr)	1.9	0.9	0.05	2.9	1.0	2.0
Total inflow TP Load (mt)	50.7	24.3	1.4	48.1	3.4	127.9
Total Outflow Volume (ac-ft)	297,603	284,780	27,708	136,466	35,549	782,106
Flow-weighted Mean Outflow TP (ppb)	47	14	16	97	12	41
Total Outflow TP Load (mt)	17.1	5.0	0.55	16.4	0.5	39.6
Hydraulic Residence Time (d)	16.1	13.5	N/A	18.9	11.0	15.4*
TP Retained (mt)	33.7	19.2	0.9	31.7	2.9	88.3
TP Removal Rate (g/m ² /yr)	1.25	0.74	0.03	1.90	0.83	1.2
Load Reduction (%)	66 %	79 %	61	66 %	85 %	69%
TP Retained to Date (mt)	240	51	0.9	110	25	427
TP Outflow to Date (ppb)	38	16	16	105	19	40

Note: "TP retained to date" is based on the period of record for each STA. The STA-1W record begins in WY1995; the STA-2 record begins in WY2002; the STA-5 record begins in WY2001; and the STA-6 record begins in WY1998. STA-3/4 begins in October of WY2004.

Table 4-2. Summary of STA operations and issues. Operational phases: (1) Start-up, inundate for vegetation growth. No discharge, phase ends when cell demonstrated net improvement in phosphorus and mercury. (2) Stabilization: discharge, phase ends when 12-month outflow TP \leq 50 ppb. (3) Post-stabilization: after stabilization phase.

STA	Operational Status	Other Issues
STA-1E	Under construction by USACE. Substantially completed in June 2004. Initial flooding began in summer 2004	Working with USACE and FDEP to finalize operating permits
STA-1W	Fully operational; in stabilization phase; in WY2004, there was a diversion of 17,000 ac-ft and 3.1 mt of TP with a flow-weighted mean TP average of 148 ppb into the Refuge because the capacity of the STA-1W inflow structure was exceeded	Had STA-1E been operational, the TP loads and concentrations from the EAA prior to entering the Refuge would have been lower; performance enhancements are under way
STA-2	Fully operational; in stabilization phase	Design of an additional 2,015-acre flow-way is under way
STA-3/4	Start-up operations began in October 2003; construction was completed in 2004	Performance enhancements are under way, including vegetation conversion and construction of a PSTA demonstration project
STA-5	Fully operational; in stabilization phase; in WY2004, there was a diversion of 37,630 ac-ft and 17 mt of TP with a flow-weighted mean TP average of 367 ppb through G-406	Performance enhancements are under way; design of an additional 2,565-acre flow-way is under way
STA-6	Fully operational; in post-stabilization phase	STA-6 Section 2 is in final design

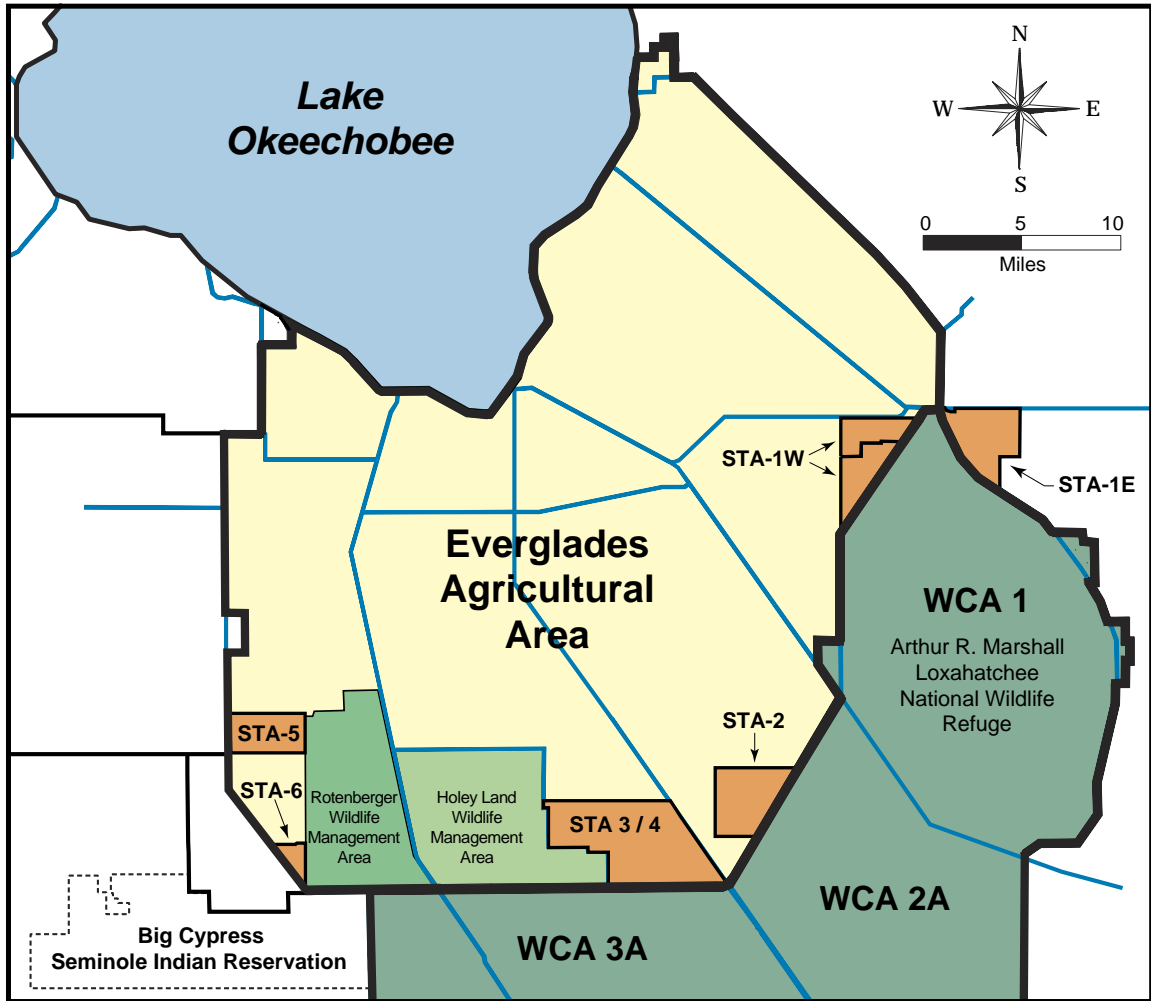

Figure 4-1. Location of STAs.

STA-1E

The construction of Stormwater Treatment Area 1 East (STA-1E) is being managed by the U.S. Army Corps of Engineers (USACE). Construction of the inflow and outflow pump stations for STA-1E was completed in 2004. The Eastern Distribution Cell and Cells 1 and 2 were completed by April 2004. All of the flow paths are scheduled to be completed by the end of 2004, and flow-through operations should commence in 2005. The USACE is designing a Periphyton-Based Stormwater Treatment Area (PSTA) demonstration project in Cell 2. A schematic of STA-1E is presented in **Figure 4-2**. Based on the 1979–1988 period of flow and total phosphorus (TP) data used during design, STA-1E should receive approximately 94,000 acre-feet (ac-ft) from the C-51 West basin, and approximately 31,000 ac-ft from the S-5A basin through the G-311 structure. Actual deliveries will vary based on hydrologic conditions in the basins. An updated water quality analysis for the C-51 West basin indicates that the TP concentrations and loads to STA-1E may be 33 percent less than previously anticipated (Pietro and Goforth, 2004). The South Florida Water Management District (SFWMD or District), the USACE, and the Florida Department of Environmental Protection (FDEP) are presently working to resolve the remaining issues associated with the operating permits for STA-1E.

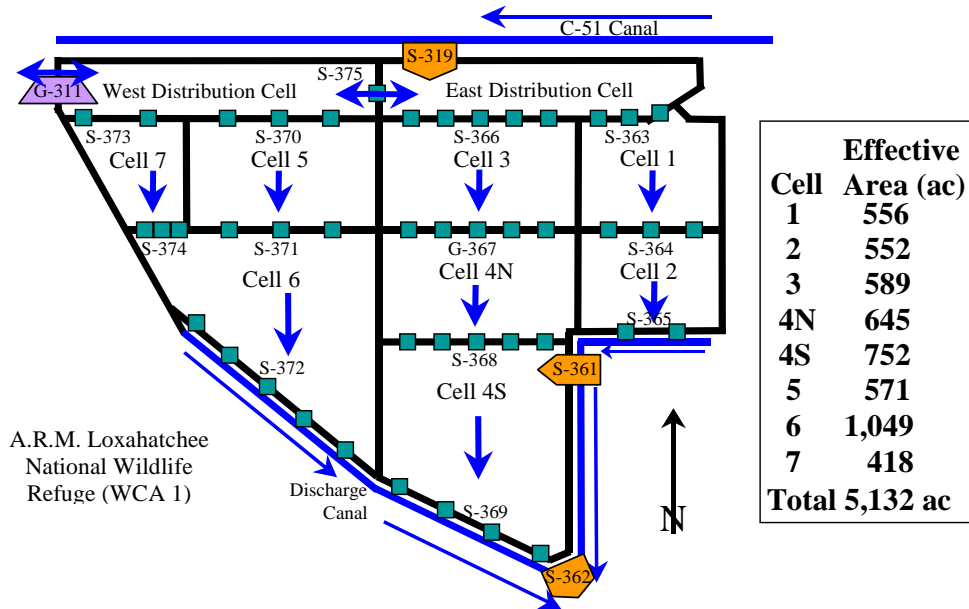

Figure 4-2. Schematic of STA-1E (not to scale). The orange boxes denote pump stations. Green boxes represent culverts.

STA-1E VEGETATION MANAGEMENT

Vegetation management at STA-1E will focus on keeping floating aquatic vegetation (FAV) at maintenance control levels. FAV “shades out” or impedes beneficial submersed and emergent vegetation which is necessary for proper STA performance. Along with the FAV treatments, emphasis will also be placed on controlling expanding emergent vegetation, mainly torpedograss (*Panicum repens*) and cattail (*Typha* spp.), which appears in submersed aquatic vegetation (SAV) cells. In Water Year 2004 (WY2004) (May 1, 2003 through April 30, 2004), 2.5 gallons of the herbicide diquat was used in STA-1E to treat 10 acres to control floating vegetation in the marsh.

Four of eight treatment cells within STA-1E are intended to be “start-up” SAV cells but are dominated by upland terrestrial vegetation. Plans include treating 1,000 acres of terrestrial vegetation and then burning the entire cell prior to flooding. Other projects include the treatment of hardwood invasives, consisting primarily of Brazilian pepper (*Schinus terebinthifolius*) and melaleuca (*Melaleuca quinquenervia*).

STA-1E Enhancements

The BC10 STA-1E Enhancements project listed in the Long-Term Plan for Achieving Water Quality Goals in the Everglades Protection Area (Long-Term Plan) (Burns & McDonnell, 2003) was for herbicide treatment of Cells 2, 4N, 4S, and 6 and for the conversion from emergent (cattail dominant) to SAV vegetation communities. The enhancement project found in the Long-Term Plan assumed STA-1E was operating as an emergent (cattail) dominate treatment area. Since the start-up operations have not yet started in STA-1E, the start-up plan is to attempt to establish these cells from the beginning as SAV cells. Therefore, activities during WY2004 have been the inclusion of SAV as part of the STA-1E start-up plan and conducting reconnaissance of cells to determine pre-startup vegetation management activities.

STA-1W

Stormwater Treatment Area 1 West (STA-1W) contains approximately 6,670 acres of effective treatment area arranged in three flow-ways. The eastern flow-way contains Cells 1 and 3, with a combined effective treatment area of approximately 2,516 acres. The western flow-way contains Cells 2 and 4, with a combined effective treatment area of approximately 1,300 acres. The northern flow-way (Cell 5) consists of approximately 2,855 acres. In addition, STA-1W includes the STA-1 inflow basin consisting of inflow pump station S-5A, and four gated spillways (S-5AS, G-311, G-300, and G-301), which allow for tremendous operational flexibility. Based on the simulated 1965–1995 period of flow utilized in developing the 2003 Long-Term Plan, STA-1W should receive an average annual flow of approximately 159,985 ac ft (Goforth, 2004). Actual deliveries will vary based on hydrologic conditions in the basins.

Inflows to STA-1W from the STA-1 inflow basin are directed into STA-1W via the G-302 structure. Flow then moves into the northern flow-way (Cell 5) via the G-302 and G-304A–J structures and into Cells 1 through 4 via the G-303 structure (Figure 4-3). Full flow-through operations in Cells 1 through 4 have occurred since August 1994, when these cells were part of the original Everglades Nutrient Removal (ENR) Project. Full flow-through operations through Cell 5 have occurred since July 2000. A limerock berm was constructed in Cell 5 during WY2004 to improve the distribution of flow, thereby enhancing phosphorus removal. Preliminary data indicate performance of Cell 5 has improved, although it is not clear if the berm is the cause.

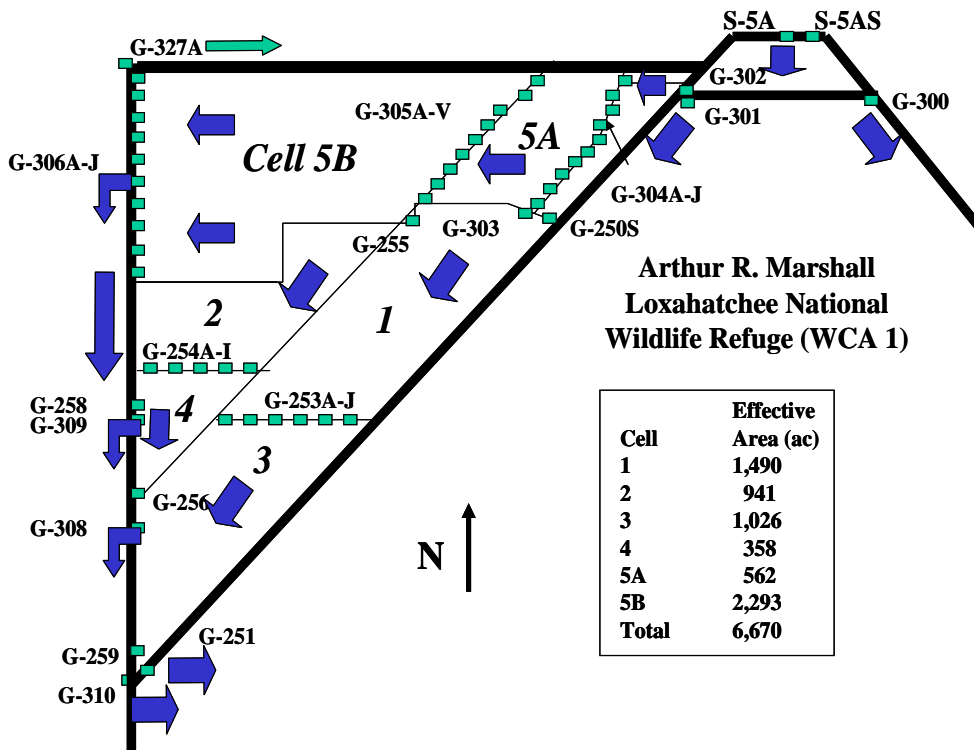

Figure 4-3. Schematic of STA-1W (not to scale).

STA-1W OPERATIONS

During WY2004, discharge to the STA-1W treatment cells via G-302 was approximately 292,690 ac-ft, equal to an average hydraulic loading rate of 3.7 centimeter per day (cm/d) over the effective treatment area of the STA. These inflows were over 80 percent higher than the long-term average annual simulated inflow for this STA, although annual variability was anticipated. Had STA-1E been in flow-through operation, these inflows would have been reduced. The volume of treated water discharged from STA-1W to the Arthur R. Marshall Loxahatchee National Wildlife Refuge (Refuge) was 297,603 ac-ft. The difference between the inflow and outflow volumes reflects the net contributions of direct rainfall, evapotranspiration (ET), seepage from the Refuge, seepage losses to adjacent lands, deep percolation, and flow measurement error. A summary of monthly flows is presented in **Figure 4-4**.

Until STA-1E is fully operational, flows from the S-5A pump station that exceed the hydraulic capacity of STA-1W will be diverted through the G-300 and G-301 structures into Water Conservation Area 1 (WCA-1). During WY2004, approximately 17,000 ac-ft (3.1 metric tons, or mt) of TP were diverted in this manner.

Extraordinarily high water levels in Lake Okeechobee during summer 2002 required the District and the USACE to institute extreme operational measures to protect the lake ecosystem and the integrity of the surrounding levee. Operational activities were directed by the federally authorized regulation schedule, referred to as Water Supply and Environment (WSE). In order to minimize the harmful freshwater releases to the St. Lucie and Caloosahatchee estuaries, WSE calls for movement of lake water to the Everglades in the maximum extent practicable without causing environmental harm. Thus, from July 2002 through February 2003, deliveries to WCA-1 were passed through STA-1W for treatment prior to discharge to the Refuge. This resulted in the inadvertent overload of flow and phosphorus loads to the STA. Immediate management activities were implemented to minimize the long-term adverse impacts of this overload event, which produced significantly positive results.

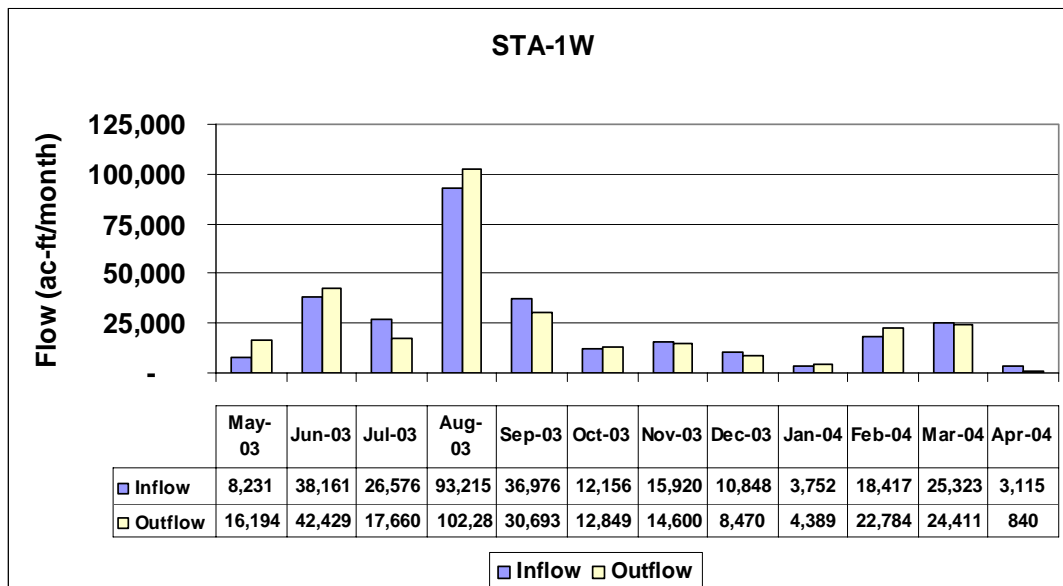

Figure 4-4. Summary of WY2004 flow for STA-1W. Note: 1 hm³ = 810.7 ac-ft.

Management Activities Implemented Since the Overload Event

1. In January 2003, STA operations were directed to terminate deliveries of lake water to STA-1W upon the conclusion of a planned two-week flow test. At that time, the latest data available (December 2002) indicated that the 12-month outflow TP concentration was 43 parts per billion (ppb), still below the target of 50 ppb, and only 8 ppb higher than the 35-ppb average when lake releases began.
2. Deliveries from Lake Okeechobee to STA-1W were terminated as of February 15, 2003. This was done despite the continuing need to lower the stage in the lake, and the effort to minimize harmful freshwater releases to the estuaries. Deliveries resumed in WY2004 at a fraction of the WY2003 amount.
3. Weekly operations meetings between STA and operations were initiated to ensure the most efficient and effective coordination of operations.
4. Cells 2 and 4 have been taken off-line for the balance of the 2004 dry season in order to give this flow-way a period of recovery. In addition, water depths were lowered in order to facilitate increased submerged vegetation growth. The cells were returned to flow-through operation in mid August 2004 to minimize the potential for bypass of untreated water to the Refuge. Observations indicate a good recovery of SAV vegetation.
5. Extensive vegetation management activities have been completed in approximately 1,500 acres of STA-1W, including herbicide application and physical removal.
6. A limerock berm was constructed in Cell 5 from February through August 2004. Preliminary indications are that the outflow concentrations from this treatment cell have improved since the combined vegetation management and limerock berm construction.
7. The District has increased the coordination with the USACE to expedite the completion of STA-1E. This STA was designed to work in concert with STA-1W to treat a portion of the stormwater runoff from the upstream EAA basin, and until it is fully operational, STA-1W will continue to be overloaded with runoff intended to go to STA-1E. The District is considering alternative operations until STA-1E is operational, the preferable choice being diversion to tide rather than alternatively diverting the extra untreated runoff to the Everglades.
8. The District successfully experimented with delivering water around the Refuge rather than through the Refuge to meet the water supply demands of the local Water Control District.
9. The District expedited the commencement of flow-through operations of STA-3/4, designed to capture and treat approximately 250,000 ac-ft per year of lake water. On February 26, 2004, flow-through operations began for the 6,500-acre eastern flow-way. On June 8, flow-through operations began in the 4,500-acre western flow-way, and on September 16, 2004, flow-through operation began in the central flow-way. It is anticipated that all future Lake Okeechobee releases, whether they are pursuant to the WSE regulation schedule, Best Management Practices (BMPs) replacement water, or for water supply to downstream receiving areas, will be directed to STA-3/4 prior to discharge to the Everglades Protection Area (EPA) when practical.

The net effect of these management actions has been a dramatic reduction in the volume of TP loads entering STA-1W (Figures 4-5 through 4-7). The STA has received less than half of the load for the 12-month period ending in April 2004, compared to the 12-month period ending in April 2003.

Additionally, the TP concentrations leaving STA-1W have recovered significantly, from a monthly high of 120 ppb in February 2003, to 25 ppb in March 2004. The 12-month TP concentration has also recovered significantly as a result of these management activities, dropping steadily from a high of 63 ppb in October and November 2003, to 46 ppb in April 2004 (Figure 4-7). Continued improvement is anticipated, and if the favorable trend of declining concentrations continues, then the 12-month outflow concentration should return to those levels seen prior to July 2002 by summer or fall 2004. However, it is not presently possible to accurately predict when the levels will recover completely.

It is important to understand that this anomalous overload event was the result of extraordinarily high water levels in Lake Okeechobee, and resulted from operations that were consistent with the federally authorized regulation schedule for Lake Okeechobee WSE in an attempt to balance the needs of regional lake and estuarine ecosystems. As a result of the District’s expedited commencement of flow-through operations in STA-3/4, this type of event is not anticipated to occur again.

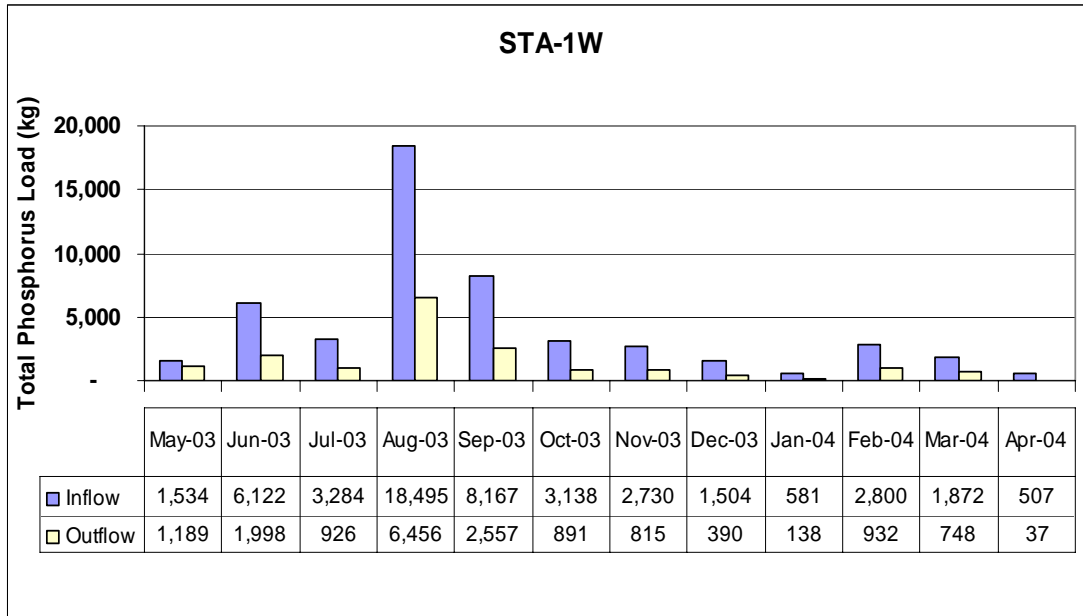

Figure 4-5. Summary of WY2004 TP loads for STA-1W.

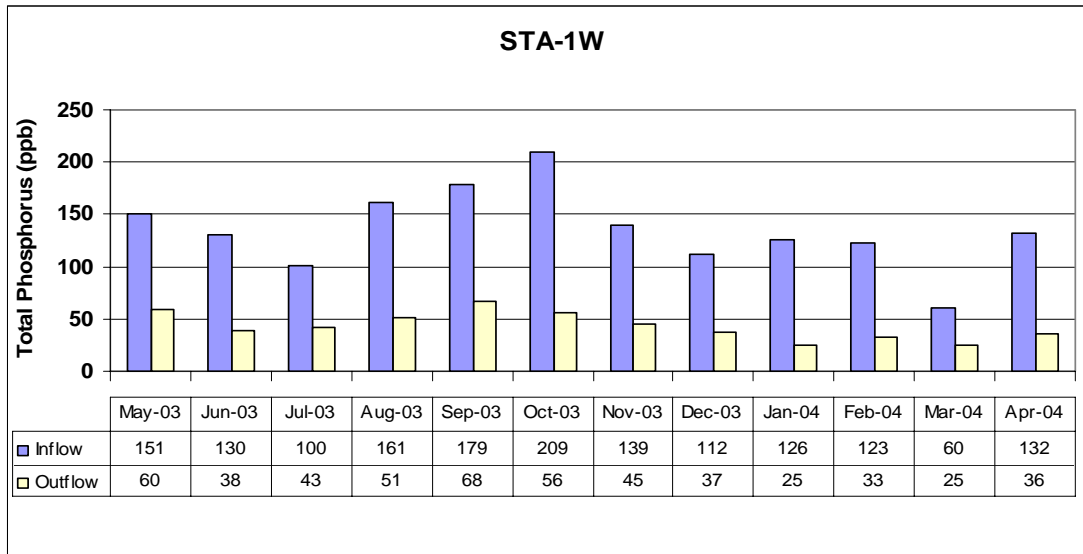

Figure 4-6. Summary of WY2004 TP concentrations for STA-1W.

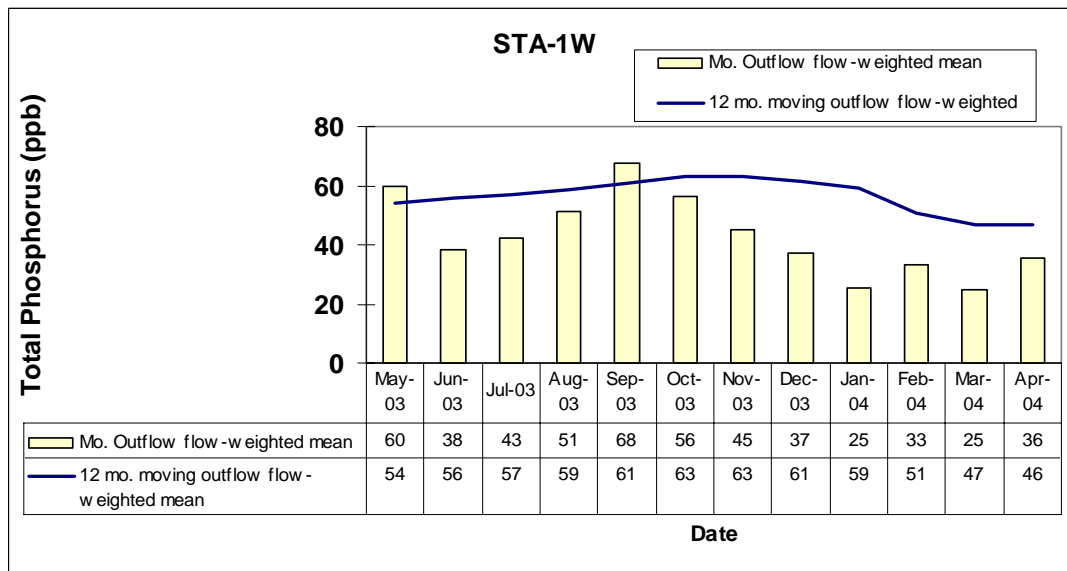

Figure 4-7. Comparison of monthly to 12-month moving average TP concentrations for WY2004 for STA-1W outflow.

STA-1W VEGETATION MANAGEMENT

Specific Condition 13(b) of the Everglades Forever Act (EFA) permit requires that the annual Everglades Consolidated Report (currently known as the *2005 South Florida Environmental Report*, or SFER) include information regarding the application of herbicides used to exclude and/or eliminate undesirable vegetation within the treatment cells. For this reporting period, the District treated a total of 650.5 acres to control nuisance vegetation in the marsh, using 132.5 gallons of diquat to treat the floating vegetation and 114.0 gallons of glyphosate to control emergent vegetation. The District used both aerial and ground-based spray equipment to apply these herbicides.

Vegetation management will focus on keeping FAV at maintenance control levels in all STAs. FAV “shades out” or impedes beneficial submersed and emergent vegetation which is necessary for proper STA performance. Along with the FAV treatments, emphasis will also be placed on controlling expanding emergent vegetation, mainly torpedograss and cattail, which appears in SAV cells.

STA-1W PERMIT WATER QUALITY MONITORING

The data presented in this section demonstrates that STA-1W was in compliance with the EFA and the USEPA’s National Pollution Discharge Elimination System (NPDES) operating permits for this reporting period and that discharges do not pose any known danger to public health, safety, or welfare. The EFA permits for STAs acknowledge that until all the STAs are fully operational, certain STAs may receive higher than normal inflows. Specifically, Specific Condition 14(c) of the STA-1W EFA permit states that STA-1W will remain in the stabilization phase of operation until STA-1E and STA-2 begin flow-through operations. At this time, STA-2 has begun flow-through operations, but STA-1E is not expected to begin flow-through operations until 2005. Therefore, STA-1W currently remains in the stabilization phase.

A five-year NPDES project inspection, including a one-time intensive monitoring program, was completed by FDEP in early 2004 with side by side coordination with the District. The result of this inspection indicated that STA-1W was in compliance with all NPDES permit conditions and requirements.

STA-1W TOTAL PHOSPHORUS

During WY2004, STA-1W received 50.7 metric tons (mt) of TP, equal to a nutrient loading rate of 1.9 grams per square meter (g/m^2). During WY2004, STA-1W received approximately 3.7 mt of TP from Lake Okeechobee. Approximately 33.7 mt of TP were removed by STA-1W during WY2004. From May 2003 through April 2004, STA-1W reduced TP discharge loads by 66 percent, compared to inflow loadings measured at G-302. Summaries of monthly TP loads and flow-weighted mean TP concentrations are presented in **Figures 4-4** and **4-5**. The flow-weighted mean outflow concentration was 47 ppb, a 67-percent reduction from the inflow concentration of 141 ppb measured at G-302. For informational purposes, the geometric mean TP concentration of the discharge was calculated as 41 ppb, using auto-sampler data from G-251 and G-310. The moving 12-month flow-weighted mean TP outflow concentration for STA-1W ranged from 46 to 63 ppb (**Figure 4-7**).

STA-1W OTHER WATER QUALITY PARAMETERS

Water quality parameters with Class III standards are identified in **Table 4-3**. The monitoring data for non-phosphorus parameters at STA-1W during this reporting period are presented in Appendix 4-1 of the 2005 SFER – Volume I and are summarized in **Table 4-4**. Temperature, specific conductance, dissolved oxygen (DO), and pH values reported in this chapter are field measurements. Ametryn and atrazine concentrations were higher in the outflow than the inflow, although these herbicides are not used within this STA. Compliance with the EFA permit is determined based on the following three-part assessment.

1. If the annual average outflow concentration does not cause or contribute to violations of applicable Class III water quality standards, then STA-1W shall be deemed in compliance.
2. If the annual average concentration at the outflow causes or contributes to violations of applicable Class III water quality standards, but it does not exceed or is equal to the annual average concentration at the inflow stations, then STA-1W shall be deemed in compliance.
3. If the annual average concentration at the outflow causes or contributes to violations of applicable Class III water quality standards, and it also exceeds the annual average concentration at the inflow station, then STA-1W shall be deemed out of compliance.

Discharges from STA-1W were determined to be in compliance with the permit by satisfying criterion one above for all non-phosphorus and non-DO parameters with applicable numeric state water quality standards. Concentrations of DO were lower than the Class III numeric standard. Annual average concentrations of total dissolved solids and dissolved chloride were slightly higher at the outflow compared to the inflow. However, because these parameters have no applicable numeric state water quality standards, STA-1W is deemed to be in full compliance with the permit. Additional requirements for DO are listed in Administrative Order AO-002-EV and are discussed below. Mercury monitoring results are also discussed in Chapter 2B of the 2005 SFER – Volume I.

The District has included the following documentation to satisfy the remaining monitoring requirements of the EFA permit.

- The District has performed all sampling and analysis under the latest FDEP-approved CompQAP No. 870166G (June 1999).
- A signed copy of this statement is provided in Appendix 4-2 of the 2005 SFER – Volume I.

Table 4-3. Water quality parameters with Class III criteria specified in Section 62-302.530, Florida Administrative Code (F.A.C.).

Parameter	Units	Class III Criteria
Dissolved Oxygen	mg/L	Greater than or equal to 5.0 mg/L
Specific Conductivity	µmhos/cm	Not greater than 50% of background or greater than 1,275 µmhos/cm, whichever is greater
pH	standard units	Not less than 6.0 or greater than 8.5
Turbidity	NTU	Less than or equal to 29 NTU above background conditions
Unionized Ammonia	mg/L	Less than or equal to 0.02 mg/L
Alkalinity	mg/L	Not less than 20 mg/L
Total Iron	µg/L	Less than or equal to 1,000 µg/L

Table 4-4. Summary of annual arithmetic averages and flow-weighted means for all parameters other than TP monitored in STA-1W. For the purpose of these comparisons, flow-weighted means are calculated as the quotient of the cumulative product of the mean daily flow and the sample concentration divided by the corresponding cumulative daily flows.

Parameter	Arithmetic Means			Flow-Weighted Means			
	<u>Inflow</u>	<u>Outflow</u>		<u>Total Inflow</u>		<u>Total Outflow</u>	
	S5A	G251	G310	n	Conc.	n	Conc.
Temperature (°C)	25.1	24.2	24.9	-NA-	-NA-	-NA-	-NA-
Dissolved Oxygen (mg/L)	4.2	1.7	3.9	-NA-	-NA-	-NA-	-NA-
Specific Conductivity (µmhos/cm)	1,172	1,151	1,168	-NA-	-NA-	-NA-	-NA-
pH	7.5	7.4	7.6	-NA-	-NA-	-NA-	-NA-
Turbidity (NTU)	8.3	2.1	3.0	-NA-	-NA-	-NA-	-NA-
Total Dissolved Solids (mg/L)	764	760	771	15 (26)	766	27 (52)	786
Unionized Ammonia (mg/L)	0.0084	0.0028	0.0027	16 (27)	0.0098	26 (50)	0.0026
Orthophosphate as P (mg/L)	0.067	0.017	0.013	32 (52)	0.096	48 (103)	0.028
Total Dissolved Phosphorus (mg/L)	0.074	0.023	0.020	32 (52)	0.104	46 (97)	0.036
Sulfate (mg/L)	87.0	74.3	83.0	15 (26)	90.1	27 (52)	88.1
Alkalinity (mg/L)	265	275	261	15 (26)	279	27 (52)	274
Dissolved Chloride (mg/L)	160	163	170	15 (26)	136	27 (52)	161
Total Nitrogen (mg/L)	3.12	2.36	2.51	17 (28)	4.11	25 (50)	2.56
Total Dissolved Nitrogen (mg/L)	3.01	2.23	2.34	15 (26)	3.89	25 (50)	2.44
Nitrate + Nitrite (mg/L)	0.622	0.022	0.105	17 (28)	0.992	25 (50)	0.142
Ametryn (µg/L)	0.059	0.058	0.062	4 (7)	0.054	6 (8)	0.061
Atrazine (µg/L)	0.625	0.408	0.475	4 (7)	0.428	6 (8)	0.652

-NA- : Not Applicable

n: number of samples with flow (total number of samples)

STA-1W DISSOLVED OXYGEN MONITORING

Introduction

DO concentrations fluctuate naturally in marsh environments, such as the Everglades, routinely falling below the Class III water quality criterion of 5 milligrams per liter (mg/L). STAs also experience natural fluctuations in DO that routinely fall below 5 mg/L, as observed in DO data collected in the Everglades Nutrient Removal Project (ENR Project Monitoring Report Appendices, 1995–1998), and as reported in the 1999 Everglades Interim Report, and in the 2000–2004 Everglades Consolidated Reports. The FDEP recognized the phenomenon of fluctuating DO concentrations in the EFA permit issued to the District for STA-1W (Administrative Order No. AO-002-EV in Exhibit C of Permit No. 503074709, April 13, 1999). To address DO in STA discharges, Section II of the Administrative Orders requires that the District provide the FDEP with an annual report consisting of an analysis demonstrating that DO levels in STA discharges do not adversely change the downstream Everglades ecology or the downstream water quality. The analysis is based on the following:

- Comparison of DO levels in STA discharges with background conditions in receiving waters
- Evaluation of DO levels at representative interior Everglades marsh stations, demonstrating that STA discharges fully maintain and protect the existing designated uses of the downstream waters and that the level of water quality is consistent with applicable antidegradation requirements
- Evaluation of whether discharges are necessary or desirable and are otherwise in the public interest
- Depiction of the daily and seasonal diel cycles for STA DO discharges during the period covered by the STA annual report
- Comparison of STA effluent with other historical DO data from the EPA, including data from interior marsh stations within the Refuge (receiving effluent from STA-1W), the Rotenberger Wildlife Management Area (RWMA) tract (receiving effluent from STA-5), and any other locations downstream of the STA discharges
- Consideration of the influences of temperature, seasonal weather conditions, aquatic community type, and hydropattern on the diel cycle of the STA discharges

The District developed the following plan to comply with the DO requirements of the Administrative Orders for STA-1W. Under the plan, DO concentrations are measured quarterly with HydrolabTM, DataSonde[®], or MiniSonde[®] probes at 30-minute intervals for four consecutive days at the following locations:

- On the south side of the C-51 canal upstream of S-5A (**Figure 4-3**)
- Downstream of the G-251 and G-310 discharge structures (**Figure 4-3**)
- At sites along the X, Y, and Z transects in the periphery of the interior Refuge marshes downstream of the combined discharges (**Figure 4-8**)

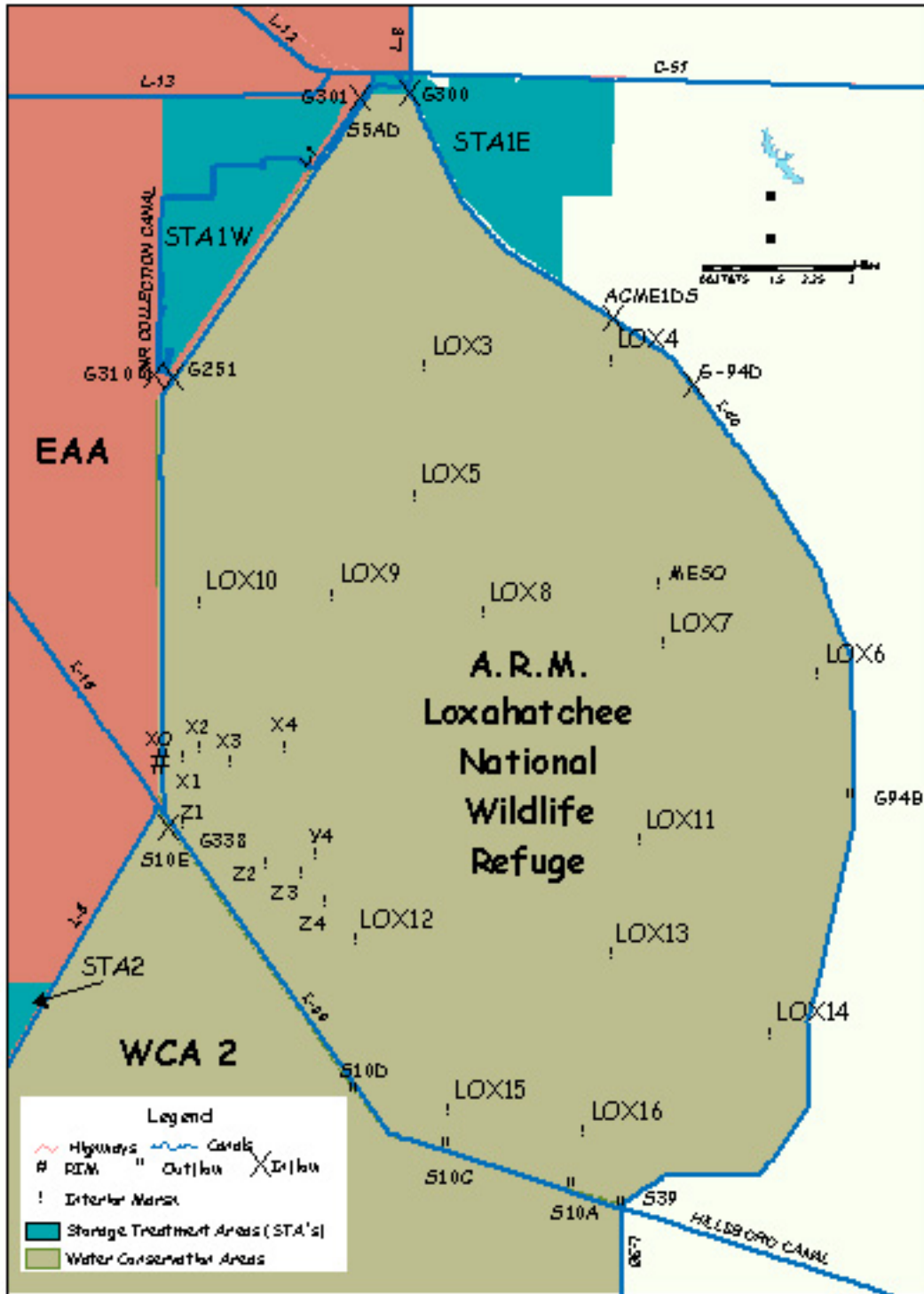

Figure 4-8. Location and classification of water quality monitoring stations in the Refuge.

Sampling Dates

Diel oxygen measurement dates and sites associated with STA-1W for WY2004 are provided in **Table 4-5**.

Table 4-5. Deployment dates for diel oxygen measurements at STA-1W structures and associated downstream marsh sites. The station, MESO01, is located in an open slough area in WCA1, in the vicinity of the District's mesocosm experiment site.

Event Dates		Structures			Sites Monitored in Refuge
Start	End	Inflow	Outflow		
07/21/2003	07/25/2003	----	----	----	X1, X2, X3, Y4, Z1, Z4, MESO01
08/04/2003	08/07/2003	S5AU	G251D	G310	-----
09/15/2003	09/19/2003	S5AU	G251D	G310	X1, X2, X3, X4, Y4, Z1, Z3
11/03/2003	11/09/2003	S5AU	G251D	G310	X1, X2, X3, X4, Y4, Z1, Z2, Z3, Z4
01/05/2004	01/09/2004	S5AU	G251D	G310	X1, X2, X3, X4, Y4, Z1, Z2, Z3, Z4
03/08/2004	03/12/2004	----	----	----	X1, X2, X3, X4, Y4, Z1, Z2, Z3, Z4

Comparison of Dissolved Oxygen in STA-1W Discharges with Dissolved Oxygen at Downstream Marshes

Comparisons of DO in STA-1W discharges with DO at downstream marsh sites in the Refuge provide an indication of whether the discharge is affecting the marsh DO concentration or the diel oxygen cycle. The summary statistics for STA-1W outflows and Refuge marsh transect sites are presented in **Table 4-6**. Discharges from STA-1W structures G-251 and G-310 constitute the flow in the L-7 rim canal unless bypasses are made through G-301, or there are outflows from the interior Refuge marsh. The DO concentration and concentrations of other constituents in the discharges affect water quality and vegetation along the fringe of the interior marsh. At times when rim canal stage is higher than interior marsh stage, rim canal water will flow into the interior marsh. The extent of penetration is dependent on stage differential. Consequently, STA-1W discharges can affect the quality of water in the interior marsh up to several kilometers from the rim canal.

Examination of the data in **Table 4-6** and the notched box and whisker plots in **Figure 4-9** indicates that the median diel DO values in discharges from G-251 and G-310 were significantly greater than the values at transect sites Z1, X1, Z2 and Y4. This significance exists because the notches for the G-251 and G-310 plots, which represent the approximate 95-percent confidence interval (95% C.I.) for the medians, do not overlap the notches for Z1, X1, Z2, and Y4. Non-overlapping notches indicate that data sets being compared are significantly different.

Further comparisons of medians and notches indicates G-251 had significantly lower DO concentrations than concentrations measured at sites X3, Z3, Z4, X4, and MESO01. Site X2 is not significantly different from G-251. DO concentrations in G-310 discharges were significantly greater than concentrations measured at transect sites X2, X3, and Z3. Sites X4 and MESO01 were not significantly different from G-310, while site Z4 was significantly greater than G-310 as well as all of the other marsh sites.

The STA-1W discharges must travel several kilometers down the L-7 canal before reaching the transect locations. Analysis of the data indicates that diel DO concentrations in the STA-1W discharges do not negatively affect the low DO concentrations observed at marsh transect stations Z1, X1, Z2, the closest to the canal, or the more interior marsh sites X2, X3, Z3, Z4, Y4, X4, and MESO01. The diel DO patterns observed at Z1, X1, and Z2 are largely due to the long-term effects of TP loading to the rim canal. Diel oxygen patterns at the more interior marsh transect sites, which are rainfall dominated, are the result of water depth and habitat vegetation differences. Ultimately, TP load reductions to the Refuge should improve DO conditions in the marsh fringe areas affected by rim canal water penetration. The complete DO data sets collected during WY2004 are presented in Appendix 4-3 of the 2005 SFER – Volume I.

Table 4-6. Statistical summary of diel DO at outflow stations (G-251D and G-310) and transect stations (X, Y, Z, and Mesocosm) in the Refuge during six deployment periods.

Location	Station	Number of Measurements	Mean	Minimum	Median	Maximum	Standard Deviation
Outflow	G251D	554	2.58	0.21	2.10	6.91	1.79
	G310	556	3.80	1.45	3.31	7.72	1.72
Transect X	X1	912	0.96	0.02	0.98	4.21	0.67
	X2	1,017	2.26	0.01	2.19	9.10	1.49
	X3	802	2.88	0.76	2.54	7.77	1.45
	X4	823	3.25	0.66	3.09	6.96	1.18
Transect Y	Y4	891	1.92	0.04	1.79	8.53	1.04
Transect Z	Z1	543	1.12	0.06	0.74	3.48	0.96
	Z2	582	1.83	0.00	1.29	9.21	1.77
	Z3	578	2.42	0.77	2.34	5.03	0.92
	Z4	552	3.48	0.26	3.66	7.15	1.48
Mesocosm	MESO01	179	3.57	1.11	2.60	9.08	2.32

Note: See Appendix 4-4, Table 2 for statistical summaries by event and diel parameter.

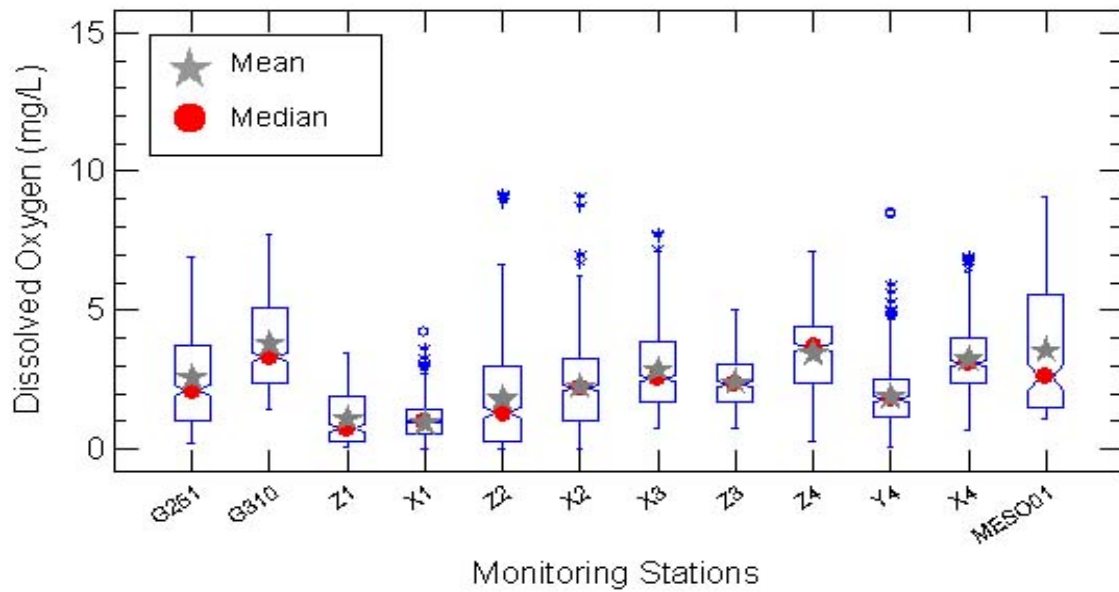

Figure 4-9. Notched box and whisker plots of diel DO measurements at STA-1W outflow stations (G251D and G310) and along transect sites in the Refuge during eight monitoring periods. The notch on a box plot represents the 95% C.I. about the median, which is represented by the narrowest part of the notch. The top and bottom of the box represent the 75th and 25th percentiles, respectively. The whiskers represent the highest and lowest data values that are within two standard deviations of the median. Values above and below the whiskers are greater than two standard deviations from the median. Notches that do not overlap indicate that the data represented by the boxes being compares are significantly different at the 95% C.I.

STA-1W ENHANCEMENTS

In Fiscal Year 2003 (FY2003), the District, with funding assistance from the FDEP and the USEPA through FDEP Grant Agreement No. G0040, completed the construction of a limerock berm in Cell 5B of STA-1W. The purpose of the limerock berm project is to demonstrate the benefits of improved hydraulics through compartmentalization at full scale. The monitoring phase of the limerock berm project was initiated in FY2003, continued in FY2004, and will continue into FY2005. In FY2004, a tracer project was initiated in Cell 5 of STA-1W to document the ability of the limerock berm to improve hydraulic distribution within the treatment cell. The results of the tracer project will be presented in next year's report.

STA-1W enhancements (**Figure 4-10**) will consist of the following component elements:

- Construction of a new levee across Cell 1, together with a series of fully operable control structures
- Construction of a new levee across Cell 2, together with a series of culverts for improved flow distribution
- Herbicide treatment in those parts of Cells 1 and 2 to be converted to SAV
- Herbicide treatment of Cell 3 for removal of emergent macrophyte vegetation to permit development of SAV
- Construction of a small seepage pumping station (designated as G-327B) near the northwest corner of Cell 5B, included in the design to permit withdrawal from the seepage canal to maintain stages in the SAV Cell 5B
- Replacement of existing structure G-255 with a fully operable control structure (nominal capacity of approximately 585 cubic feet per second, or cfs)
- Addition of electric motors and telemetry equipment to allow remote operations of the gates at the G-304 inflow structures to Cell 5
- Addition of a 150 cfs structure to replace G-256 as the primary discharge for Cell 4

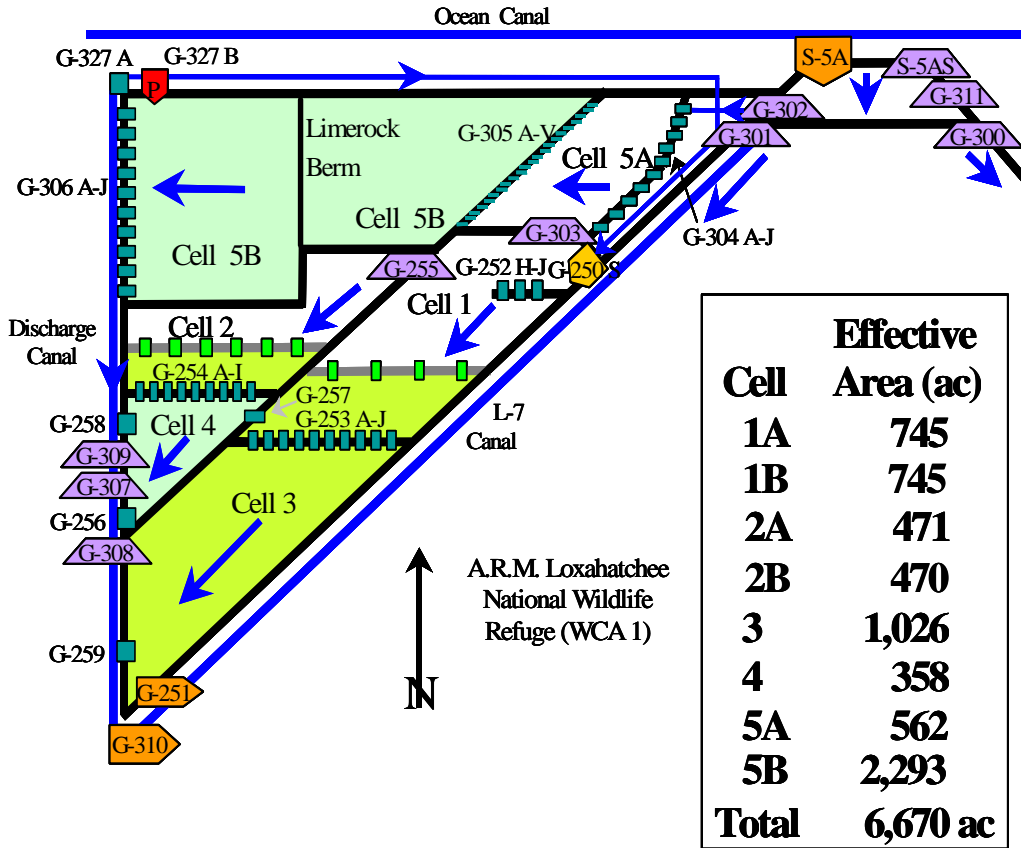

Figure 4-10. STA-1W enhancements.

STA-2

Stormwater Treatment Area 2 (STA-2) contains approximately 6,430 acres of effective treatment area arranged in three parallel flow-ways. The eastern flow-way (Cell 1) consists of approximately 1,990 acres of effective treatment area. The center flow-way (Cell 2) consists of approximately 2,220 acres of effective treatment area. The western flow-way (Cell 3) consists of approximately 2,220 acres of effective treatment area. A schematic of STA-2 is presented in **Figure 4-11**. Based on the simulated 1965–1995 period of flow, the STA should receive a long-term average of approximately 232,759 ac-ft. Actual deliveries will vary based on hydrologic conditions in the basins.

Water enters STA-2 from the S-6 and G-328 pump stations, is distributed by the inflow canal across the north end of the treatment cells, and flows via gravity south through the three treatment cells. Treated water is collected and discharged to WCA-2A via the G-335 outflow pump station. Discharges are directed to areas within WCA-2A that are already impacted by elevated nutrient levels.

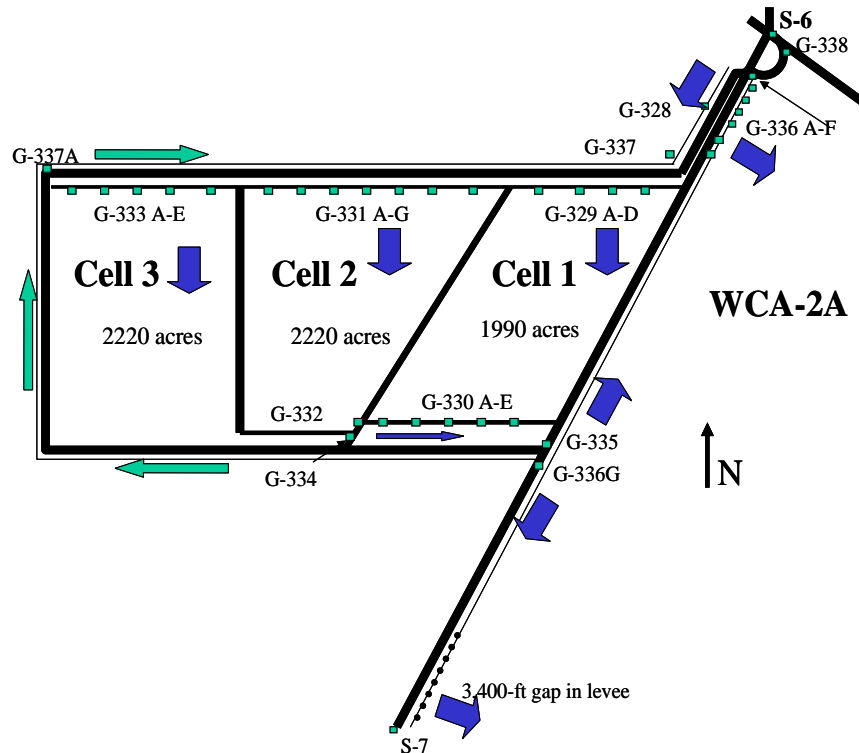

Figure 4-11. Schematic of STA-2 (not to scale).

STA-2 OPERATIONS

Start-up operations for STA-2 began upon the completion of the three treatment cells in 1999. At that time, water levels were maintained for optimal growth of desired vegetation. Inflow to STA-2 began in June 1999 from G-328, the 450 cubic feet per second (cfs) pump station. Construction of 3,040 cfs outflow pump station G-335 was completed in 2000, with the final operational testing completed in October 2000. The final construction component (connection of the S-6 pump station to the inflow canal) was completed during the dry season of 2001, a schedule that minimized the potential downtime of pump station S-6. The outflow structures in Cell 1 (G-330s) were retrofitted with weir plates to increase water depths in the cell, which should reduce the frequency and duration of drydowns within the cell.

During WY2004, approximately 256,938 ac-ft of water was captured and treated by STA-2. This was about 25 percent more than the anticipated average annual flow contemplated during design, although annual variability was anticipated. This inflow loading was equal to an average hydraulic load of 3.3 cm/d over the treatment area. The annual volume of treated water discharged to WCA-2A was 284,780 ac-ft. The difference between the inflow and outflow volumes reflects the net contributions of direct rainfall, ET, seepage losses to adjacent lands, deep percolation, and flow measurement error. A summary of monthly flows is presented in **Figure 4-12**. No flows were diverted around STA-2 during WY2004.

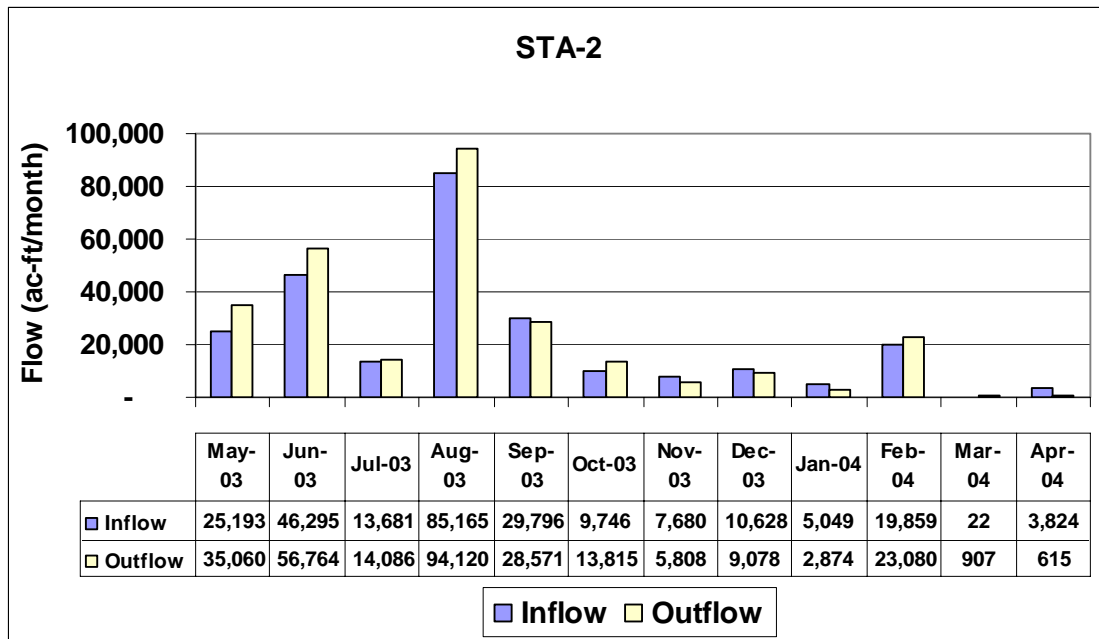

Figure 4-12. Summary of WY2004 flows for STA-2 (Note: 1 hm³ = 810.7 ac-ft).

STA-2 VEGETATION MANAGEMENT

Specific Condition 13(b) of the EFA permit requires that the annual report include information regarding the application of herbicides to exclude and/or eliminate undesirable vegetation within the treatment cells. For this reporting period, the District treated 782 acres and applied a total of 163.0 gallons of the herbicide glyphosate to control torpedograss and cattail, and 95.75 gallons of diquat to control FAV and cattail in Cells 2 and 3. Both aerial and ground-based spray equipment were used to apply these herbicides. Additionally, two submersed treatments were conducted on hydrilla (*Hydrilla verticillata*) in STA-2, Cell 3 using the active ingredient endothall. Two formulations were used: (1) 393 liquid gallons of Aquathol K, and (2) 2,571 granular pounds of Aquathol Super K.

STA-2, Cell 3 has a total area of 2,270 acres and is dominated by SAV; however, 500 acres of emergent cattail marsh exists in the south east section. Vegetation coverage maps from December 2003 are found in Appendix 4-12 of the 2005 SFER – Volume I. It has been identified in the Long-Term Plan that this emergent portion be converted to SAV. Due to the performance of this cell and the pending results of the STA-3/4 demonstration project this conversion will be deferred.

Vegetation management will focus on keeping FAV at maintenance control levels in all STAs. FAV “shades out” or impedes beneficial submersed and emergent vegetation which is necessary for proper STA performance. Along with the FAV treatments, emphasis will also be placed on controlling expanding emergent vegetation, mainly torpedograss and cattail, which appears in SAV cells.

STA-2 PERMIT WATER QUALITY MONITORING

Monitoring data collected for STA-2 demonstrate that STA-2 was in compliance with the EFA and NPDES operating permits for WY2004 and that discharges do not pose any known danger to public health, safety, or welfare. The EFA and NPDES operating permits were issued for this project on September 29, 2000. Each treatment cell in STA-2 operates independently, and the permits authorize discharges when net improvement in TP and mercury is demonstrated for each cell. STA-2 Cells 2 and 3 passed the net improvement start-up tests for TP and mercury on September 13 and November 9, 2000, respectively. Cell 1 was the last of the treatment cells to meet the start-up criteria listed in the permit for mercury. After the FDEP, the USEPA, and other agencies reviewed the Cell 1 mercury situation, it was determined that the most effective way to reduce mercury concentrations in Cell 1 was to move as much water through the cell as possible to increase sulfur levels. On August 9, 2001, a draft permit modification was issued to initiate flow-through operations for Cell 1. Data collected in December 2002 and January 2004 demonstrated that Cell 1 passed the start-up test listed in the permit based on the stations identified for that purpose. Additional monitoring continues to increase the understanding of mercury in the STA. Currently STA-2 is in the stabilization phase, having demonstrated net improvement in TP and mercury. In addition, Specific Condition 14(B) of the EFA permit states that STA-2 will remain in the stabilization phase of operation until STA-1E and STA-3/4 begin flow-through operations. Presently STA-1E is still in the construction phase and is not expected to begin flow-through operations until 2005, subject to vegetation grow-in and soil phosphorus stabilization.

STA-2 TOTAL PHOSPHORUS

Under the design objectives of the EFA, STA-2 is achieving its interim discharge goal of less than 50 ppb for TP. Although the hydraulic loading to STA-2 was higher than the design criteria, the TP loading to the system was less than the design amount. During WY2004, the STA received 24.3 mt of TP, equal to a nutrient loading rate of 0.90 g/m². During WY2004, STA-2 received approximately 0.8 mt of TP from Lake Okeechobee. STA-2 removed approximately 19.2 mt of TP during WY2004. Monthly discharge concentrations were considerably lower than inflow concentrations. For example, from May 2002–April 2004, STA-2 reduced discharge loads of TP by 79 percent. Summaries of monthly TP loads and flow-weighted mean TP concentrations are presented in **Figures 4-13** and **4-14**, respectively. The annual flow-weighted mean outflow concentration was 14 ppb, an 81-percent reduction from the inflow concentration of 77 ppb. For informational purposes, the annual geometric mean discharge TP concentration for STA-2 was 15 ppb for WY2004. If an outflow concentration of less than 50 ppb in accordance with the EFA permit for STA-2 had been achieved, then Cells 2 and 3 would have passed the stabilization phase if not for the requirement that STA-2 should remain in the stabilization phase until STA-1E and STA-3/4 begin full flow-through operation. The 12-month moving average TP concentration from STA-2 decreased from 18 ppb to 14 ppb during the course of WY2004 (**Figure 4-15**).

STA-2 OTHER WATER QUALITY PARAMETERS

The monitoring data for non-phosphorus parameters at STA-2 during this reporting period are presented in Appendix 4-5 of the 2005 SFER – Volume I, and are summarized in **Table 4-7**. Compliance with the EFA permit is determined based on the following three part assessments:

1. If the annual average outflow concentration does not cause or contribute to violations of applicable Class III water quality standards, then STA-2 shall be deemed in compliance.
2. If the annual average concentration at the outflow causes or contributes to violations of applicable Class III water quality standards, but it does not exceed or is equal to the annual average concentration at the inflow stations, then STA-2 shall be deemed in compliance.
3. If the annual average concentration at the outflow causes or contributes to violations of applicable Class III water quality standards, and it also exceeds the annual average concentration at the inflow station, then STA-2 shall be deemed out of compliance.

Except for specific conductivity, discharges from STA-2 were determined to be in compliance with the permit by satisfying criterion one above for all non-phosphorus and non-DO parameters with applicable numeric state water standards. Additional requirements for DO are listed in Administrative Order AO-006-EV and are discussed below. Mercury monitoring results are discussed in Chapter 2B, and also in Appendix 4-7 of the 2005 SFER – Volume I.

The District has included the following documentation to satisfy the remaining monitoring requirements of the EFA permit:

- The District has performed all sampling and analysis under the latest FDEP-approved CompQAP No. 870166G (June 1999).
- A signed copy of this statement is provided in Appendix 4-2 of the 2005 SFER – Volume I.

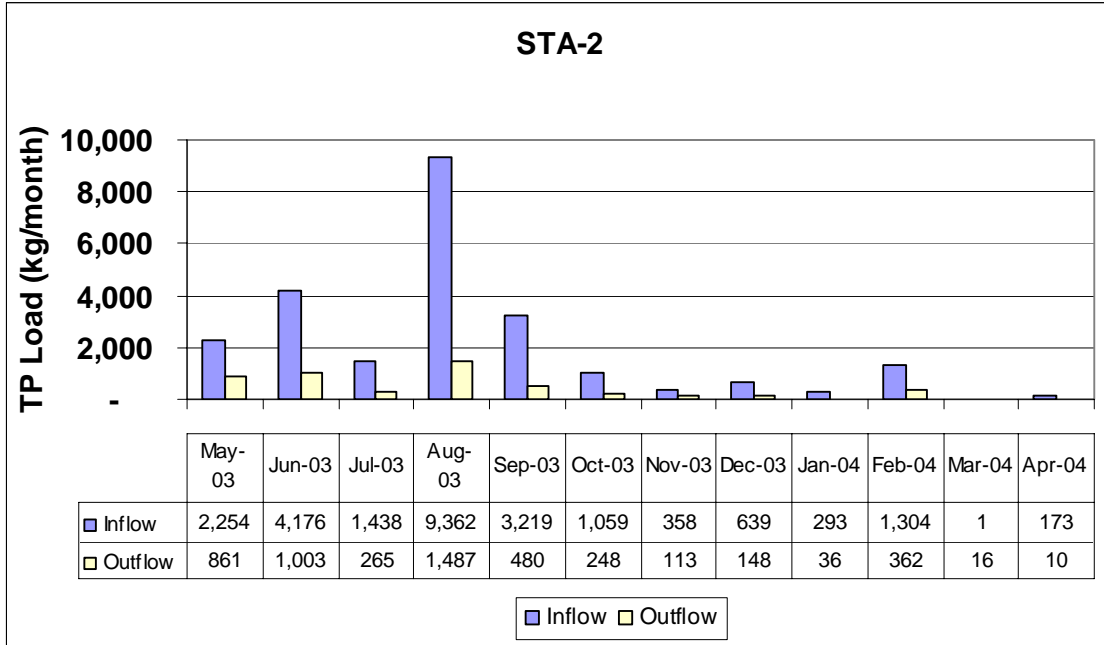

Figure 4-13. Summary of WY2004 TP loads for STA-2.

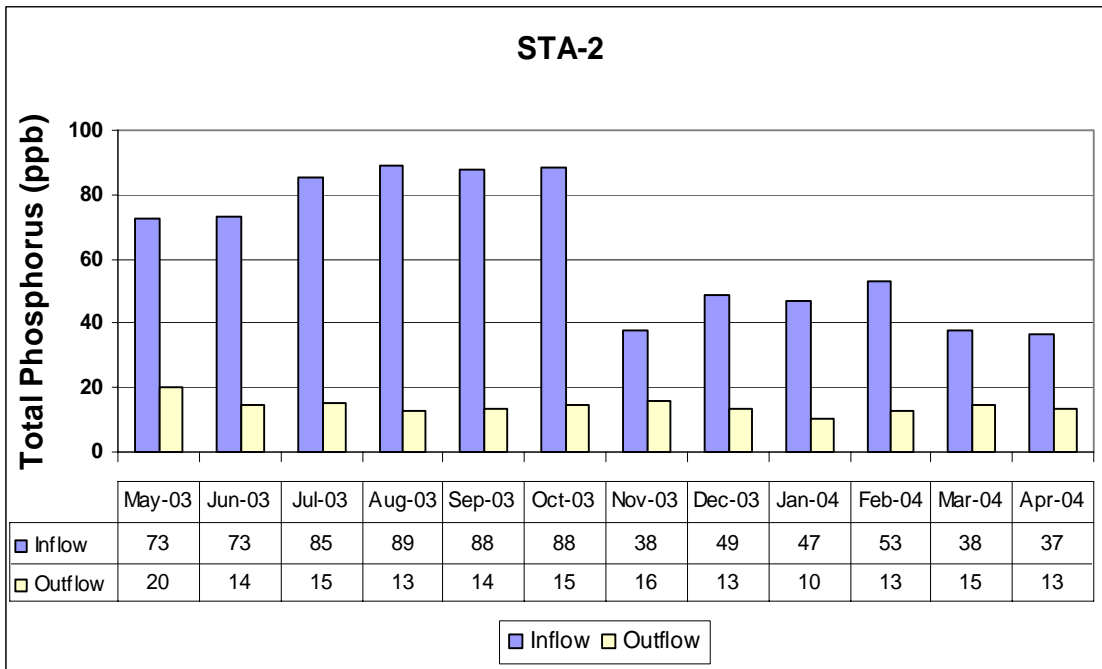

Figure 4-14. Summary of WY2004 TP concentrations for STA-2.

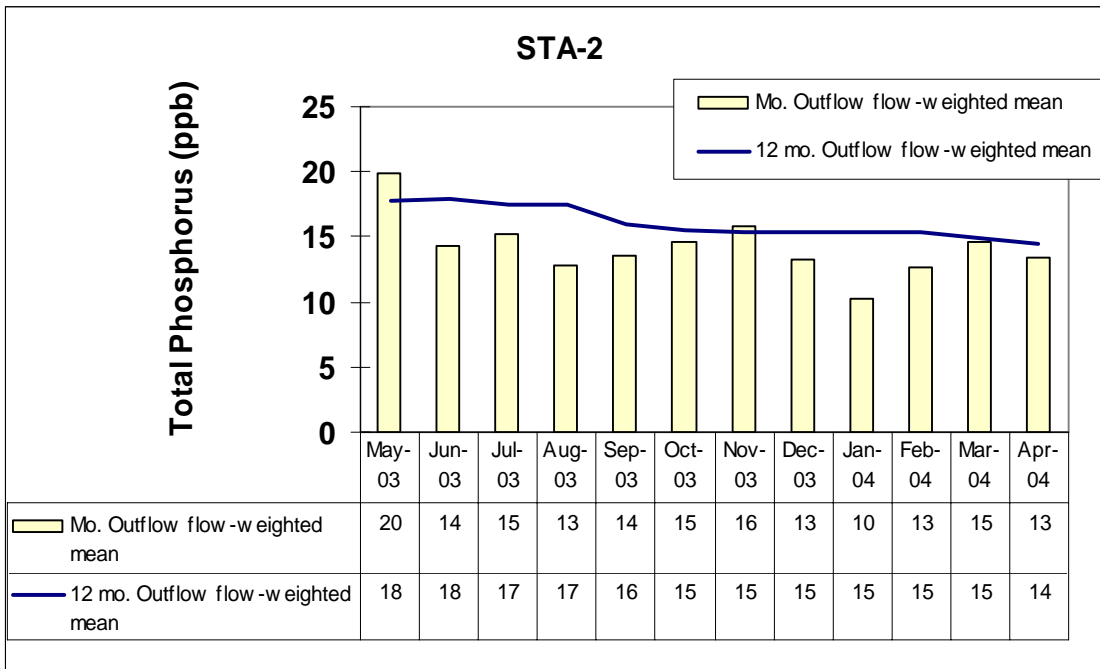

Figure 4-15. Comparison of monthly to 12-month moving average TP concentrations for WY2004 for STA-2 outflow.

Table 4-7. Summary of annual arithmetic averages and flow-weighted means for water quality parameters (other than TP) monitored in STA-2. Note that monitoring for the pesticides ametryn and atrazine is not required under the routine permit. For the purpose of these comparisons, flow-weighted means are calculated as the quotient of the cumulative product of the mean daily flow and the sample concentration divided by the corresponding cumulative daily flows.

Parameter	Arithmetic Means			Flow-Weighted Means			
	Inflow		Outflow	Total Inflow		Total Outflow	
	S6	G328	G335	n	Conc.	n	Conc.
Temperature (°C)	25.1	25.1	25.1	-NA-	-NA-	-NA-	-NA-
Dissolved Oxygen (mg/L)	3.1	4.3	4.6	-NA-	-NA-	-NA-	-NA-
Specific Conductivity (µmhos/cm)	1,305	1,557	1,261	-NA-	-NA-	-NA-	-NA-
pH	7.4	7.5	7.5	-NA-	-NA-	-NA-	-NA-
Turbidity (NTU)	3.8	3.1	1.2	-NA-	-NA-	-NA-	-NA-
Total Dissolved Solids (mg/L)	848	966	823	18 (52)	890	26 (26)	794
Unionized Ammonia (mg/L)	0.0061	0.0087	0.0032	18 (52)	0.0084	26 (26)	0.0013
Orthophosphate as P (mg/L)	0.034	0.012	0.006	32 (104)	0.068	52 (52)	0.007
Total Dissolved Phosphorus (mg/L)	0.041	0.015	0.007	31 (91)	0.073	43 (43)	0.008
Sulfate (mg/L)	82.0	54.4	69.2	18 (52)	102.5	26 (26)	77.4
Alkalinity (mg/L)	324	368	305	18 (52)	341	26 (26)	293
Dissolved Chloride (mg/L)	181	263	185	18 (52)	171	26 (26)	163
Total Nitrogen (mg/L)	3.09	2.68	2.34	18 (52)	4.14	26 (26)	2.34
Total Dissolved Nitrogen (mg/L)	2.98	2.57	2.29	18 (52)	3.94	26 (26)	2.29
Nitrate + Nitrite (mg/L)	0.542	0.378	0.107	18 (52)	1.051	26 (26)	0.185

-NA- : Not Applicable

n: number of samples with flow (total number of samples)

STA-2 DISSOLVED OXYGEN MONITORING

Introduction

STA-2 Administrative Order No. AO-006-EV in Exhibit C of the EFA STA-2 Permit (Permit No. 0126704, September 29, 2000) specifies the same DO monitoring requirements as those for STA-1W. The District developed the following plan to comply with the DO requirements of the Administrative Orders for STA-2. Under the plan, DO concentrations are measured quarterly with Hydrolab™, DataSonde®, or MiniSonde® probes at 30-minute intervals for four consecutive days at the following locations:

- At the inflow side of the S-6 pump station
- At the inflow side of the G-328 pump station
- At sites along the N, C, S, and Z transects in the northwest section of WCA-2A, located downstream of culverts distributing flow from discharge pump station G-335

Sampling Dates

Diel oxygen measurement dates and sites associated with STA-2 for WY2004 are provided in **Table 4-8**.

Table 4-8. Deployment dates for diel oxygen measurement at STA-2 structures and associated downstream marsh sites.

Event Dates		Structures			Sites Monitored in Water Conservation Area 2
Start	End	Inflow	Outflow		
06/02/2003	06/06/2003	----	----	----	C.25, N.25, N1, N4
08/25/2003	08/28/2003	S6	G328	G335	-----
10/20/2003	10/25/2003	----	----	----	C.25, C1, N.25, N1, N4, S4
12/15/2003	12/18/2003	S6	G328	G335	-----

Note: See Appendix 4-4, Table 3 for statistical summaries by event and diel parameter.

Comparison of Dissolved Oxygen in STA-2 Discharges with Dissolved Oxygen at Downstream WCA-2A Sites

Direct comparisons of DO in STA-2 discharges with DO at downstream marsh sites in WCA-2A (**Figure 4-16**) cannot be made for WY2004 because Hydrolab™ deployment dates differed. However, to satisfy permit requirements, summary statistics for STA-2 discharges and WCA-2A marsh transect sites are presented in **Table 4-9**. Notched box and whisker plots for the sites are presented in **Figure 4-17**. The complete data sets collected at all sites during WY2004 are found in Appendix 4-6 of the 2005 SFER – Volume I.

The data indicate that diel DO concentrations in G-335 discharges were statistically greater than DO concentrations at all of the marsh transect sites. DO at site N.25 was significantly greater than at the other marsh sites.

STA-2 ENHANCEMENTS

Enhancements to STA-2 (**Figure 4-18**) include construction of interior levees and associated water control structures in each of the three treatment cells, as well as conversion of emergent vegetation to SAV in the new downstream cells and construction of a 1,813-acre treatment cell.

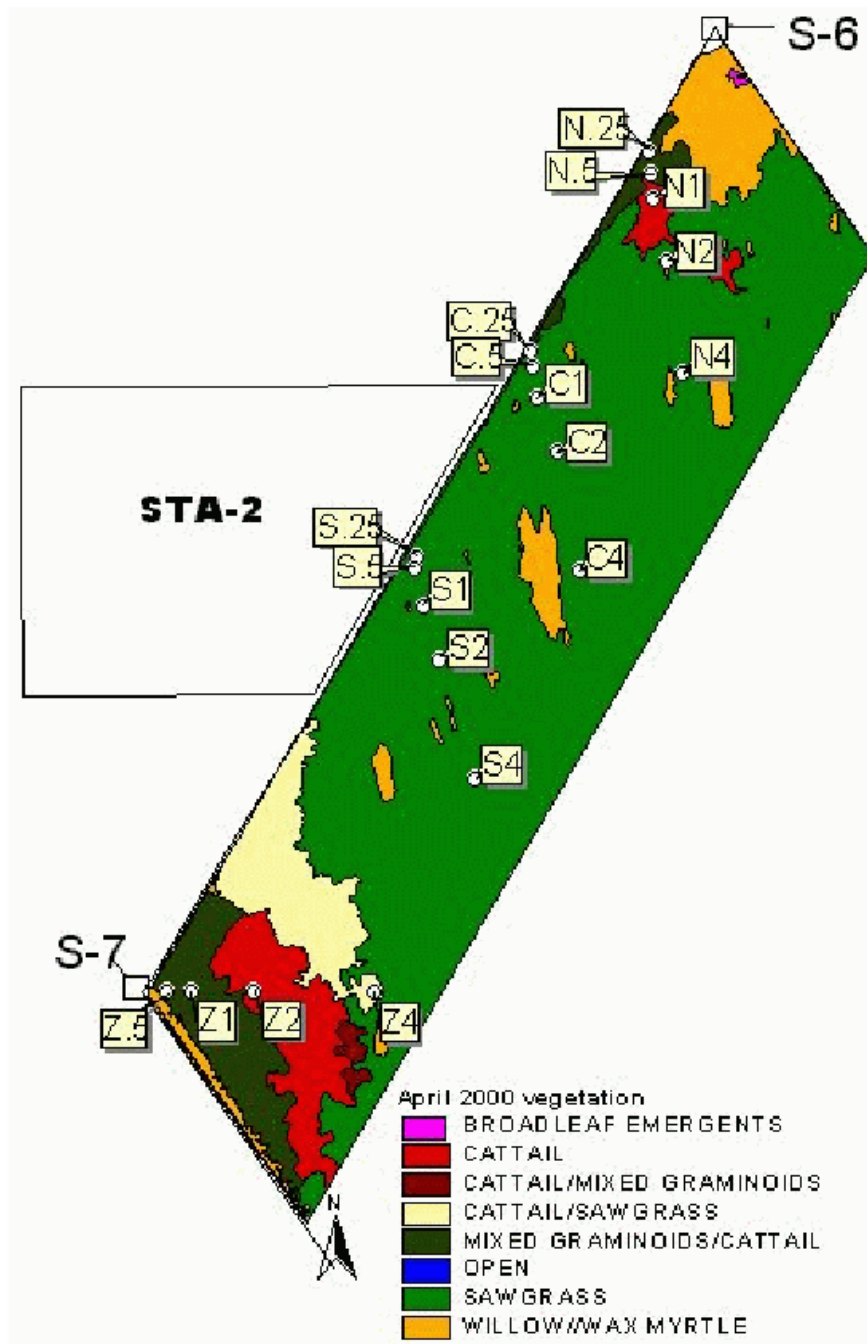

Figure 4-16. DO monitoring sites in WCA-2.

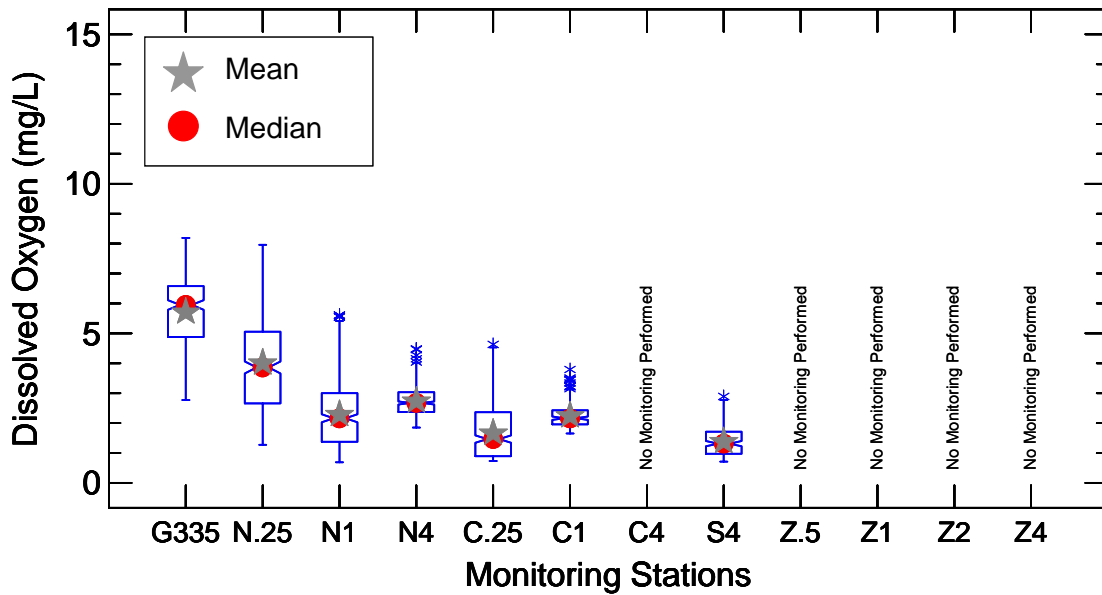

Figure 4-17. Notched-box and whisker plots of diel DO measurements at the STA-2 outflow station (G-335) and along transect sites in WCA-2 during three monitoring periods. The notch on a box plot represents the C.I. about the median, which is represented by the narrowest part of the notch. The top and bottom of the box represent the 75th and 25th percentiles, respectively. The whiskers represent the highest and lowest data values that are within two standard deviations of the median. Values above and below the whiskers are greater than two standard deviations from the median. Notches that do not overlap indicate that the data represented by the boxes being compared are significantly different at 95% C.I.

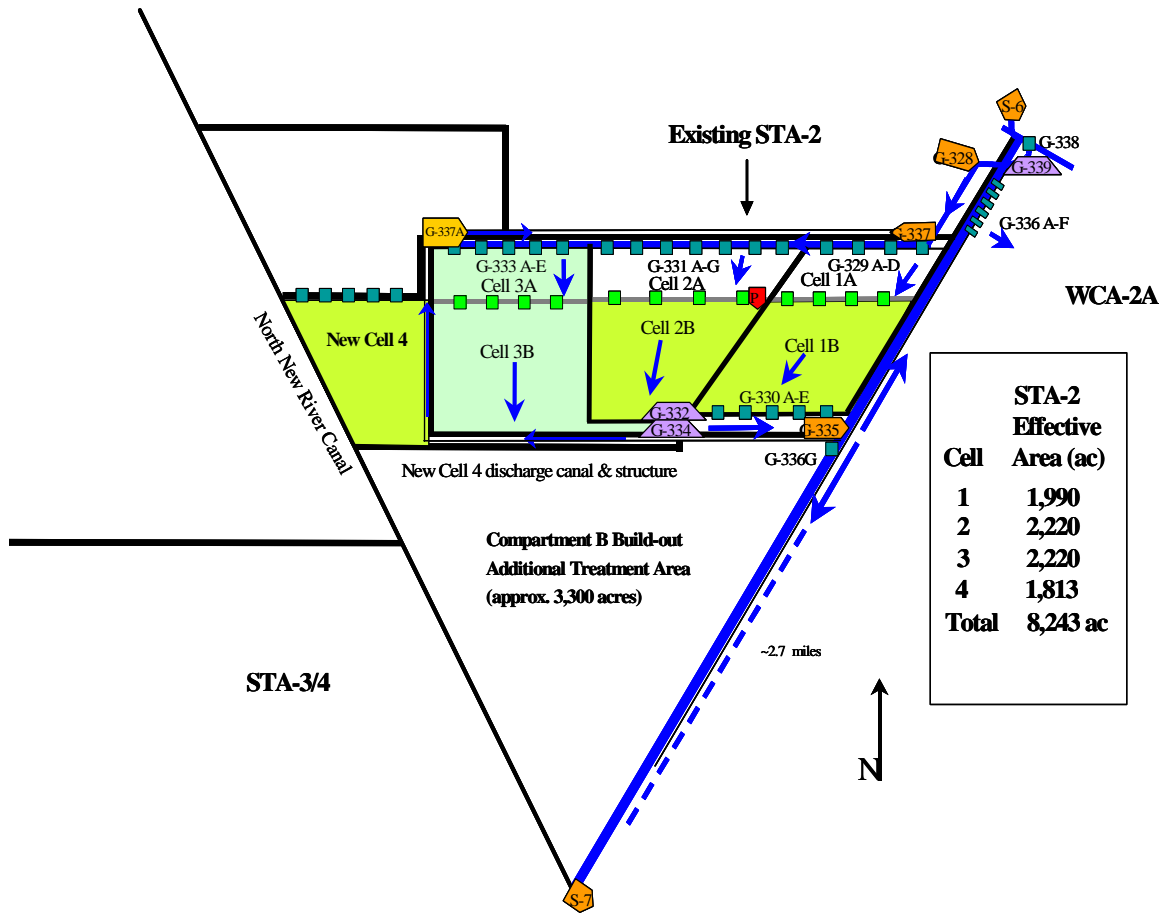

Figure 4-18. STA-2 enhancements.

Table 4-9. Statistical summary of diel DO at the outflow pump station from STA-2 and marsh stations in WCA-2 during WY2004.

Location	Station	Number of Measurements	Mean	Minimum	Median	Maximum	Standard Deviation
Outflow	G335	278	5.73	2.77	5.95	8.19	1.33
	C.25	360	1.68	0.73	1.47	4.63	0.88
Transect C	C1	181	2.26	1.65	2.16	3.79	0.41
	C4	----	----	----	----	----	----
	N.25	359	4.03	1.27	3.86	7.96	1.59
Transect N	N1	377	2.31	0.69	2.16	5.61	1.14
	N4	377	2.75	1.85	2.67	4.48	0.52
Transect S	S4	181	1.41	0.71	1.31	2.89	0.52
	Z.5	----	----	----	----	----	----
Transect Z	Z1	----	----	----	----	----	----
	Z2	----	----	----	----	----	----
	Z4	----	----	----	----	----	----

STA-3/4

Stormwater Treatment Area 3/4 (STA-3/4) is the largest of the STAs, with approximately 16,543 acres of effective treatment area. A schematic of STA-3/4 is presented in **Figure 4-19**. During an average year, STA-3/4 should receive approximately 400,000 ac-ft of runoff from upstream basins, and approximately 250,000 ac-ft of Lake Okeechobee releases. At the design performance of 50 ppb, the STA should remove more than 50 tons of phosphorus. STA-3/4 uses the existing S-7 and S-8 pump stations as the outflow facilities. Refurbishment of those stations is under way.

The most significant milestone during this last reporting period was the completion of STA-3/4, the world's largest constructed wetland. Three of the construction contracts for STA-3/4 were awarded to the IT Corporation (IT), which filed for bankruptcy in January 2002. Although work continued on the three contracts during the period from January through May 2002, progress was slow due to contractor financial issues. The Shaw Group purchased IT in May 2002, and assumed management of the three contracts. Although construction was not wholly complete by the October 1, 2003 target date, the facilities were sufficiently complete to begin start-up operations by October 1, 2003. On January 15, 2004, the 6,500-acre Flow-way 1 of STA-3/4 passed the start-up requirements of the operating permits. On February 25, 2004, the first discharges of treated water from this STA began. On June 7, 2004, the 4,580-acre Cell 3 began discharging. Cells 2A and 2B had been kept off-line while enhancements were implemented. The 2,542-acre Cell 2A was inundated in October 2003 and presently is fully vegetated. The 2,894-acre Cell 2B is the site of the new PSTA demonstration project, and also the location of a massive vegetation conversion to SAV. This flow-way passed the permit-required start-up test in August 2004. On September 16, 2004, the remaining 5,436 acre Flow-way 2 (Cells 2A and 2B) began discharging.

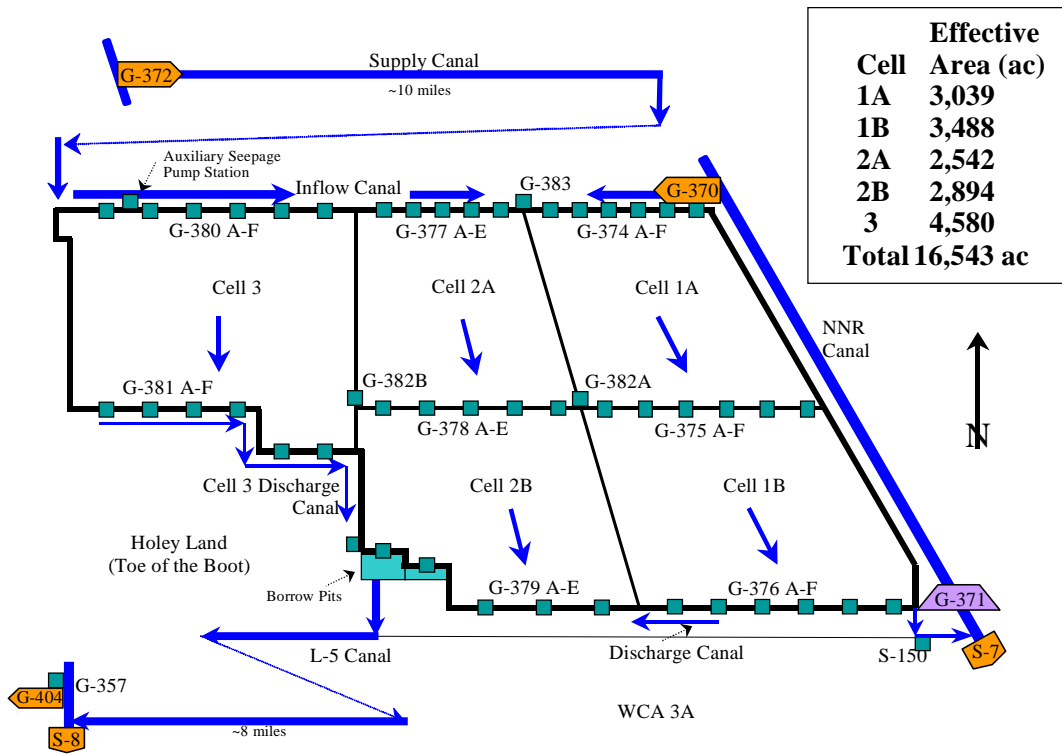

Figure 4-19. Schematic of STA-3/4 (not to scale).

STA-3/4 OPERATIONS

Although construction was not fully complete by the October 1, 2003 target date, the facilities were sufficiently complete to begin start-up operations on October 1, 2003. The FDEP operating permits were received on January 9, 2004, and by January 15, 2004, Flow-way 1 had passed the start-up tests for phosphorus and mercury. Due to dry season conditions, flow-through did not begin until February 26, 2004 for Flow-way 1. On March 19, 2004, the District received a permit modification to allow flow-through operation for Flow-way 3 in spite of elevated mercury conditions relative to the inflow levels. The modification was based on the hypothesis that flow-through conditions will lower outflow concentrations, as was demonstrated in Cell 1 of STA-2. Due to dry season conditions, flow-through did not begin until June 8, 2004 for Flow-way 3. Flow-way 3 demonstrated net improvements in mercury in August 2004. Start-up operations also began in Cell 2A in October 2003. Cell 2B was kept off-line to allow for vegetation management activities designed to convert the emergent vegetation to submerged aquatic vegetation (SAV) through herbicide and fire. In late June 2004, Cell 2B was inundated. Over 60,000 pounds of SAV were successfully transplanted from STA-2 into Cell 2B in mid-August, and Flow-way 2 began discharging on September 16, 2004.

STA-3/4 WATER QUALITY

STA-3/4 has demonstrated better than anticipated phosphorus removal performance. In WY2004, beginning in October 2003, STA-3/4 received 23,303 ac-ft of water with an average inflow of 49 ppb and a TP load of 1.4 mt. During this time frame, the STA discharged 27,708 ac-ft and a TP load of 0.55 mt, with an average concentration of 16 ppb through Flow-way 1 (**Figures 4-20** through **4-22**). For the entire period of record, from October 1, 2003 through September 2004, STA-3/4 received 445,630 ac-ft inflow water and a TP load of 48.6 mt and discharged 432,649 ac-ft and a TP load of 6.6 mt. Approximately 40 tons of phosphorus were removed, and average TP was reduced from 88 ppb down to 12 ppb, resulting in an 86-percent load reduction.

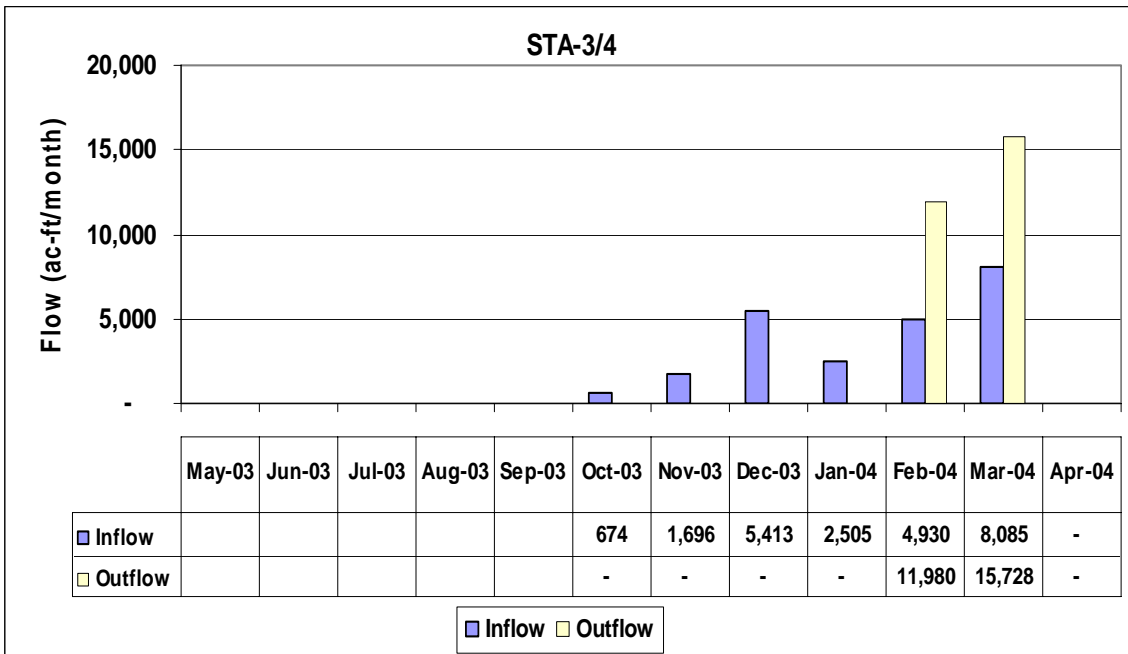

Figure 4-20. Summary of WY2004 flow for STA-3/4. Note: 1hm³ = 810.7 ac-ft.

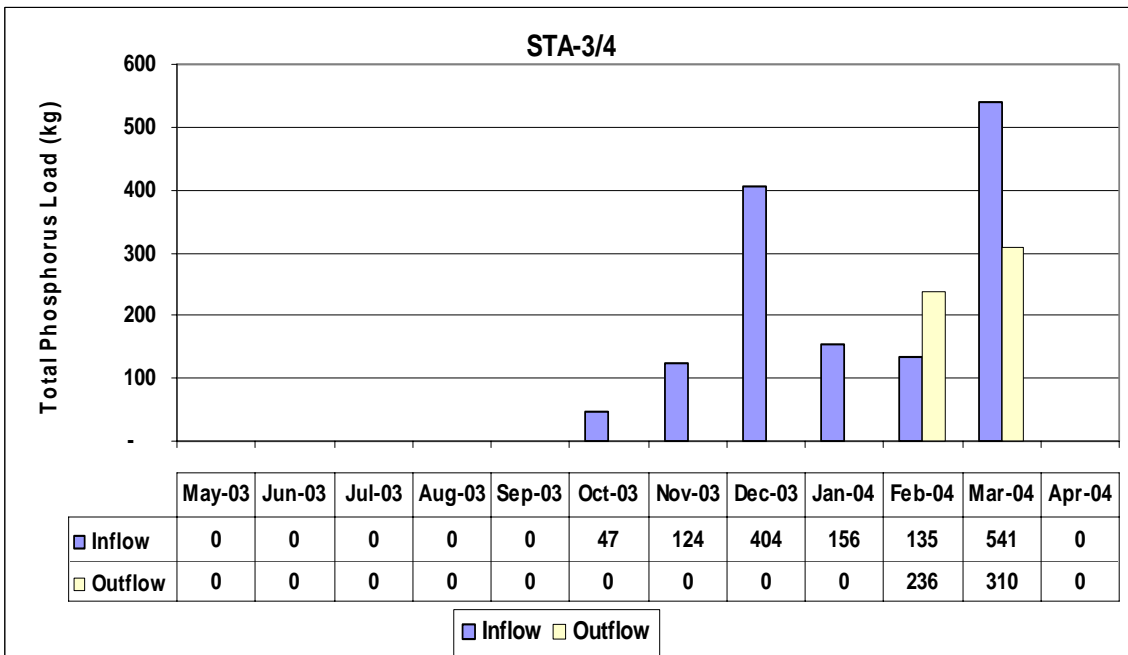

Figure 4-21. Summary of WY2004 TP loads for STA-3/4. Only Flow-way 1 was in operation during this period.

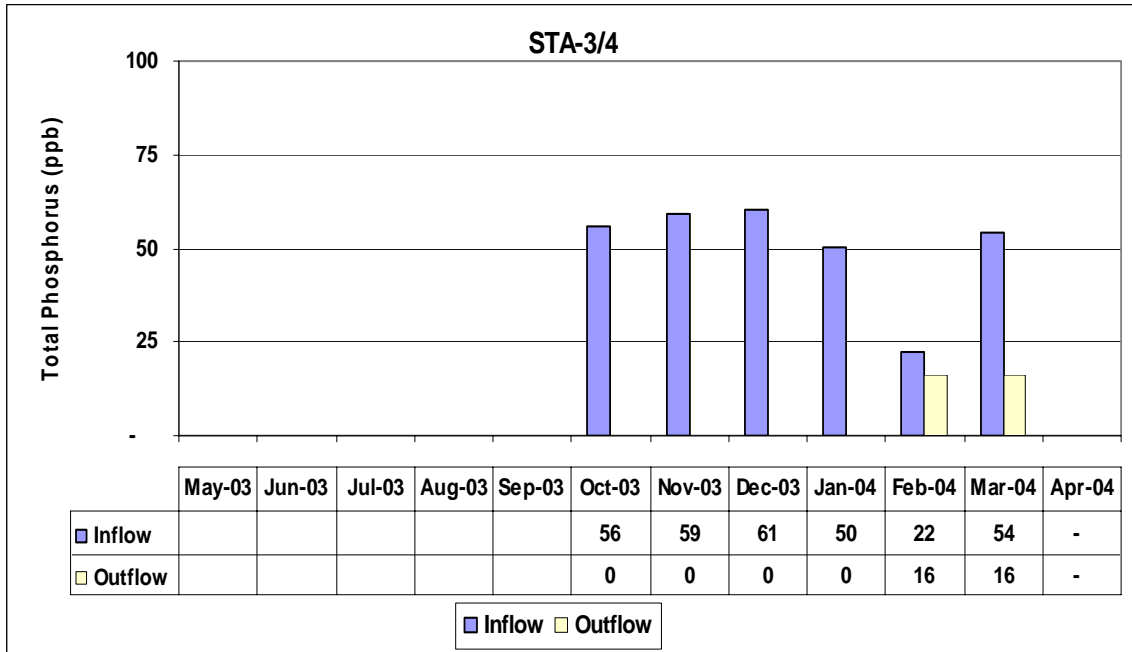

Figure 4-22. Summary of WY2004 TP concentrations for STA-3/4. Only Flow-way 1 was in operation during this period.

STA-3/4 VEGETATION MANAGEMENT

In STA-3/4, 1,506 acres of emergent grasses and cattail was treated using 1,412 gallons of glyphosate.

VEGETATION MANAGEMENT [BC84(2)]

In STA-3/4, emphasis will be placed on controlling expanding emergent vegetation, mainly torpedograss and cattail, which appears in SAV cells. In addition to these proposed maintenance treatments, vegetation management has plans to treat the hardwood non-target species, consisting primarily of Brazilian pepper and melaleuca in STA-3/4.

VEGETATION MANAGEMENT DEMONSTRATION PROJECT IN STA-3/4, CELL 2B (BC25)

In FY2004, with funding assistance from the same FDEP grant, a vegetation management demonstration project was initiated in STA-3/4, Cell 2B. The purpose of the vegetation management demonstration project is to evaluate methods for eliminating undesirable emergent vegetation and establishing SAV in the STAs. The main focus of this effort is to determine the most effective method for eliminating torpedograss and other emergent vegetation from STA treatment cells and to evaluate large scale inoculation of SAV in the same treatment cells. The torpedograss and emergent removal portion of the project is being undertaken in a 313-acre area in the southwest portion of Cell 2B, and involves experimental applications and evaluation of combinations of two types of herbicides, fire, and flooding. Baseline (pre-treatment) data on torpedograss and emergent cover were collected from December 2003 through February 2004. Herbicide applications and burning were completed from April through May 2004, and the demonstration project site was flooded in June 2004. Data on the effectiveness of the various treatments was collected in summer and fall 2004. The SAV inoculation plan was initiated in summer 2004, and involved harvesting SAV from a donor site in STA-2 and transporting the harvested plants via helicopter to STA-3/4, Cell 2B. The success of these inoculations and recovery of the donor sites will be monitored over the remainder of FY2004 and will continue into FY2005.

STA-3/4 ENHANCEMENTS

Enhancements to STA-3/4 (**Figure 4-23**) will include the following features:

- Construction of approximately 3.3 miles of interior levee, subdividing Cell 3 into Cells 3A and 3B
- Construction of additional water control structures through the new levee subdividing Cell 3 into Cells 3A and 3B
- Extension of an overhead power distribution line from the intersection of Interior Levee 3 and Interior Levee 4, extending north along Interior Levee 4 to the new levee across Cell 3, and then west along the new levee across Cell 3 (total length of approximately 3.6 miles)
- Small forward-pumping stations along the interior levees between cells in series to permit withdrawal from upstream emergent marsh cells to maintain stages in the downstream SAV cells. Supplemental flows can be transferred from Cell 2A to Cell 1A through structure G-382A, and between Cell 2A and Cell 3B through structure G-382B

- Herbicide treatment of Cells 1B, 2B, and 3B for removal of emergent macrophyte vegetation to permit development of SAV
- Inoculation of SAV from STA-2 into STA-3/4 by helicopter to accelerate vegetation recruitment
- Construction of the full-scale PSTA demonstration project (see *PSTA Investigations [BC83(3)]* and *PSTA Demonstration Project in STA-3/4 [BC83(4)]* section in this chapter for additional details)

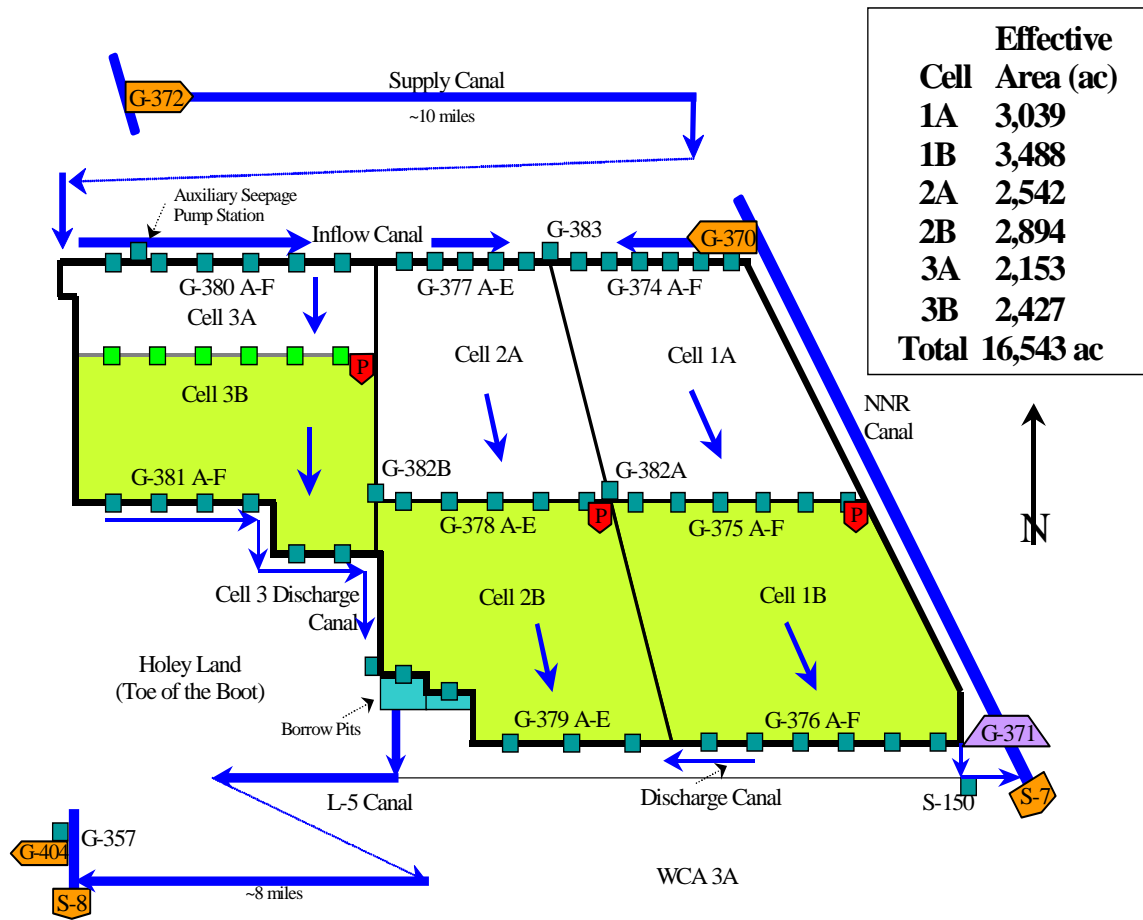

Figure 4-23. STA-3/4 enhancements.

STA-5

Stormwater Treatment Area 5 (STA-5) contains approximately 4,110 acres of effective treatment area arranged in two parallel flow-ways. The northern flow-way (Cells 1A and 1B) consists of approximately 2,055 acres of effective treatment area. The southern flow-way (Cells 2A and 2B) consists of approximately 2,055 acres of effective treatment area. A schematic of STA-5 is presented in **Figure 4-24**. Based on the simulated 1965–1995 flow period utilized in developing the 2003 Long-Term Plan, it was assumed that STA-5 would receive a long-term average annual discharge of approximately 129,083 ac-ft per year from the C-139 basin. Actual deliveries will vary based on hydrologic conditions in the basin. Runoff that exceeds the hydraulic capacity of STA-5 will be diverted through G-406.

Water enters STA-5 from the west and flows by gravity through the treatment area to the east. Treated water is collected and discharged either to the Rotenberger Wildlife Management Area or the Miami Canal, where the majority of the water moves south to the northwest corner of WCA-3A. A complete description of STA-5 is contained in Chapter 6 of the *2000 Everglades Consolidated Report*.

STA-5 OPERATIONS

During WY2004, approximately 153,080 ac-ft of water were captured and treated by STA-5. This is more than the average annual flow assumed during design, although the design anticipated annual variability. This surface inflow equates to an average hydraulic loading rate of 3.1 cm/d over the effective treatment area of the STA. During WY2004, approximately 37,630 ac-ft of C-139 basin runoff were diverted around STA-5. In the future, flows and loads that are diverted around STA-5 will be captured and treated in STA-6 Section 2, which is currently scheduled for completion by December 2006. A summary of monthly STA-5 flow is presented in **Figure 4-25**.

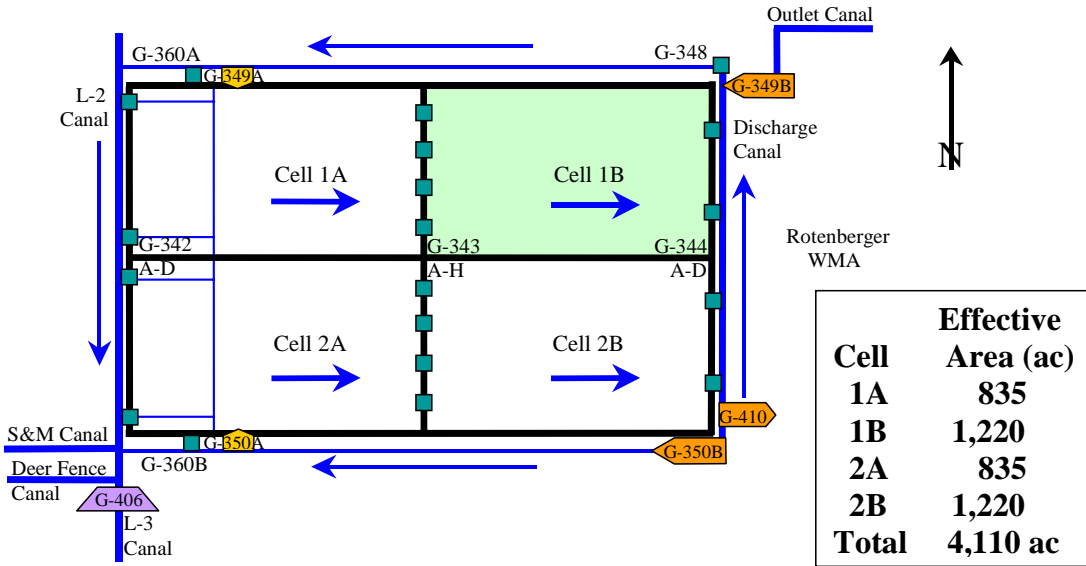

Figure 4-24. Schematic of STA-5 (not to scale).

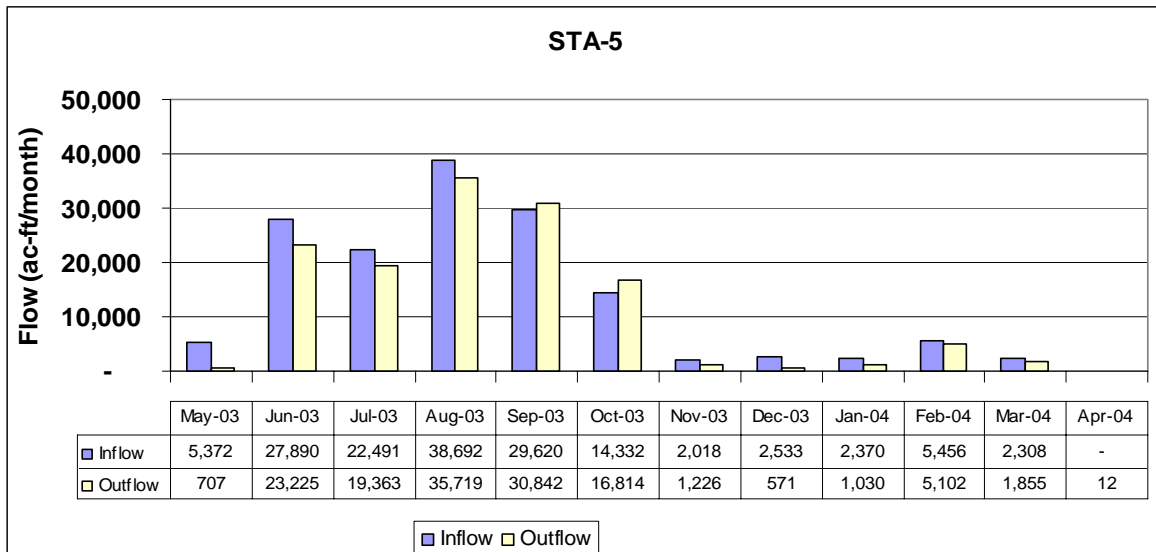

Figure 4-25. Summary of WY2004 flows for STA-5 (Note: 1 hm³ = 810.7 ac-ft).

STA-5 VEGETATION MANAGEMENT

Specific Condition 13(b) of the EFA permit requires that the annual report include information regarding the application of herbicides used to exclude and/or eliminate undesirable vegetation within the treatment cells. For this reporting period, about 89 acres of ditch banks and about 1,240 acres of marsh were treated in STA-5 to control emergent and FAV. A total of 287.5 gallons of diquat was applied to treat the FAV, and 168 gallons of glyphosate was used to control emergent and ditchbank vegetation. Both aerial and ground-based spray equipment were used to apply these herbicides. Vegetation coverage maps from December 2003 are found in Appendix 4-12 of the 2005 SFER – Volume I.

Vegetation management will focus on keeping FAV at maintenance control levels in all STAs. FAV “shades out” or impedes beneficial submersed and emergent vegetation, which is necessary for proper STA performance. Along with the FAV treatments, emphasis will also be placed on controlling expanding emergent vegetation, mainly torpedograss and cattail, which appears in SAV cells.

STA-5 PERMIT WATER QUALITY MONITORING

Except for DO, the data presented in this section demonstrate that STA-5 was in compliance with the EFA and NPDES operating permits for WY2004, and that discharges do not pose any known danger to public health, safety, or welfare. The EFA permit states that STA-5 will remain in the stabilization phase of operation until STA-6 Section 2 begins flow-through operations.

STA-5 TOTAL PHOSPHORUS

During WY2004, STA-5 received 48 mt of TP. STA-5 removed approximately 31.7 mt of TP during WY2004, equal to a removal rate of approximately 1.9 grams per square meter per year ($\text{g}/\text{m}^2/\text{yr}$). As a result of above normal runoff from the C-139 basin, approximately 37,630 ac-ft of storm water carrying approximately 17 mt of TP was diverted around STA-5 through the G-406 structure.

During WY2004, STA-5 reduced outflow loads of TP by 66 percent compared to inflow loadings. Summaries of monthly TP loads and flow-weighted mean TP concentrations are presented in **Figures 4-26** and **4-27**. The flow-weighted mean outflow TP concentration was 97 ppb, a 62-percent reduction from the inflow concentration of 255 ppb. While the outflow concentration was above the 50-ppb interim target, this does not create a violation of the operating permits, as the STA is still in the stabilization phase. Improved TP reduction is anticipated in the future as BMP measures are implemented for the C-139 basin and as the benefits of vegetation management within the STA are realized. The moving 12-month flow-weighted mean TP outflow concentration for STA-5 decreased from 134 to 95 ppb over the course of WY2004 (see **Figure 4-28**). For informational purposes, the geometric mean discharge TP concentration for STA-5 using auto-sampler data was 99 ppb for WY2004.

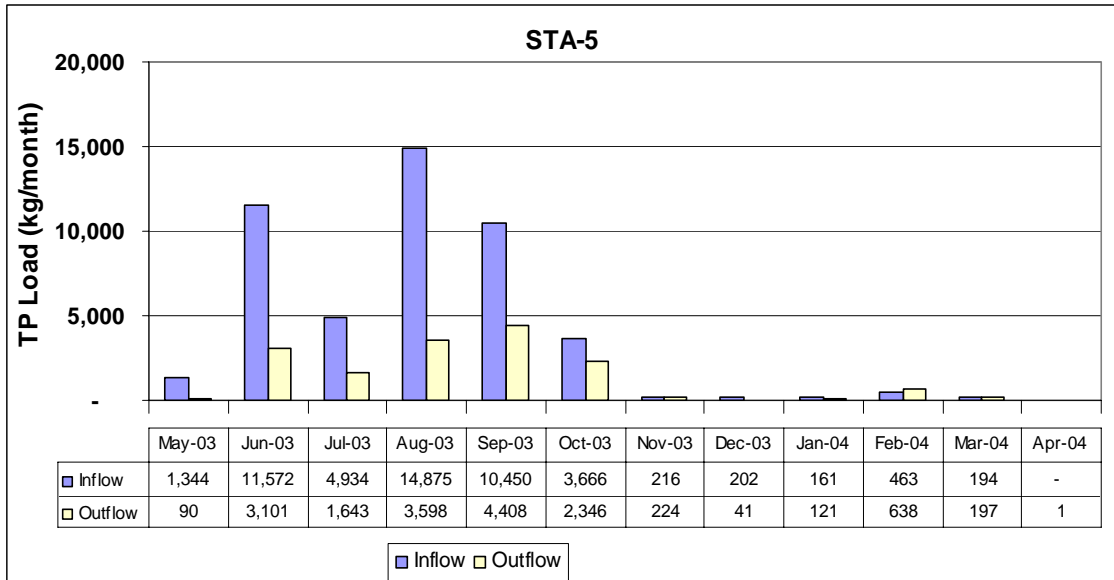

Figure 4-26. Summary of WY2004 TP loads for STA-5.

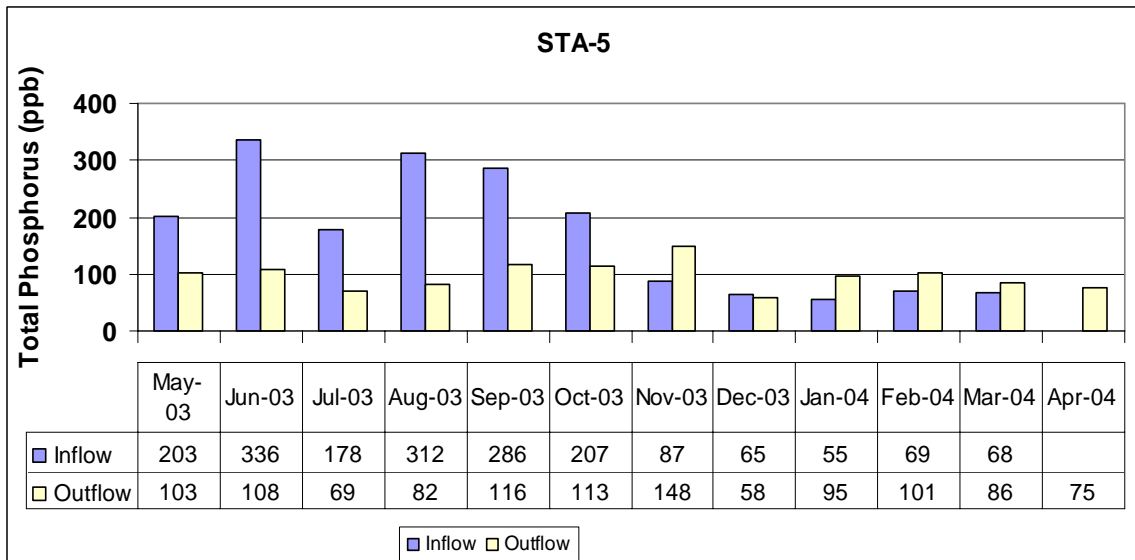

Figure 4-27. Summary of WY2004 TP concentrations for STA-5.

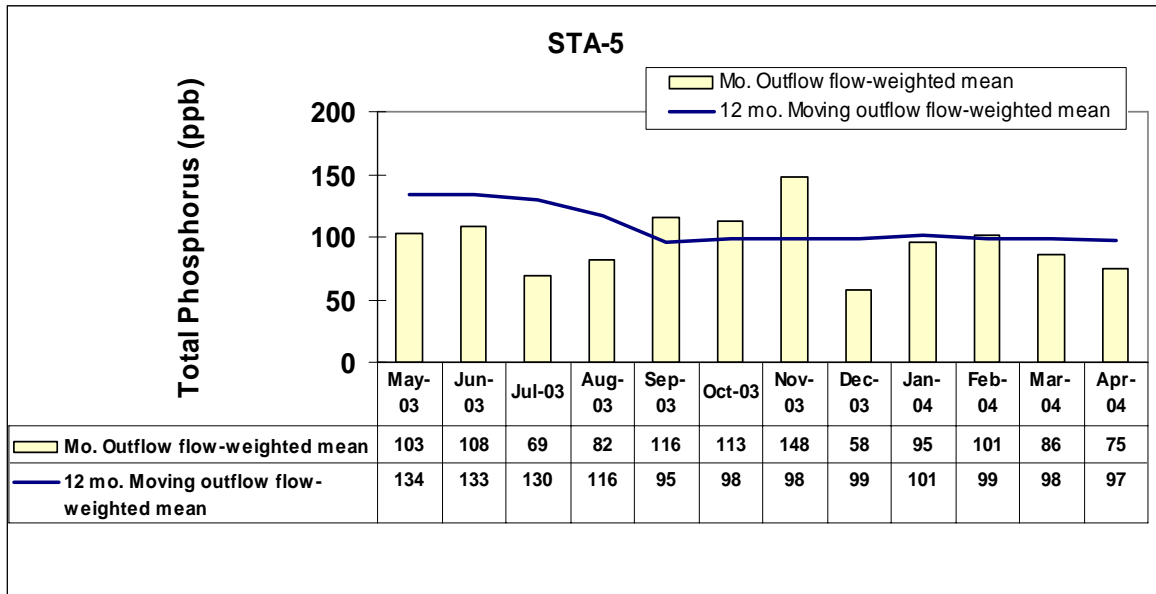

Figure 4-28. Comparison of monthly to 12-month moving average TP concentrations for WY2004 for STA-5 outflow.

STA-5 OTHER WATER QUALITY PARAMETERS

The monitoring data for non-phosphorus parameters at STA-5 during this reporting period are presented in Appendix 4-8 of this volume and summarized in **Table 4-10**. While ametryn and atrazine concentrations were detected in the outflow, these herbicides are not used within the STA. Compliance with the EFA permit is determined based on the following three-part assessment criterion:

1. If the annual average outflow concentration does not cause or contribute to violations of applicable Class III water quality standards, then STA-5 shall be deemed in compliance.
2. If the annual average concentration at the outflow causes or contributes to violations of applicable Class III water quality standards, but it does not exceed or is equal to the annual average concentration at the inflow stations, then STA-5 shall be deemed in compliance.
3. If the annual average concentration at the outflow causes or contributes to violations of applicable Class III water quality standards, and it also exceeds the annual average concentration at the inflow station, then STA-5 shall be deemed out of compliance.

Discharges from STA-5 were determined to be in compliance with the permit by satisfying criterion one above for all non-phosphorus and non-DO parameters with applicable numeric state water standards. Total dissolved phosphorus, dissolved chloride, total nitrogen, and total dissolved nitrogen concentrations were higher at the outflow compared to the inflow. However, because these parameters have no applicable numeric state water quality standards, STA-5 is deemed to be in full compliance with the permit. Of interest is that inflow concentrations of sulfate are considerably lower for STA-5 than for the other STAs. However, at this time the causes or significance are unclear. Additional requirements for DO are listed in Administrative Order AO-004-EV and are discussed below. Mercury monitoring results are also discussed in Chapter 2B of the 2005 SFER – Volume I.

The District has included the following documentation to satisfy the remaining monitoring requirements of the EFA permit:

- The District has performed all sampling and analysis under the latest FDEP-approved CompQAP No. 870166G (June 1999).
- A signed copy of this statement is provided in Appendix 4-2 of the 2005 SFER – Volume I.

Table 4-10. Summary of annual arithmetic averages and flow-weighted means for all parameters (other than TP) monitored in STA-5. For the purpose of these comparisons, flow-weighted means are calculated as the quotient of the cumulative product of the mean daily flow and the sample concentration divided by the corresponding cumulative daily flows.

Parameter	Arithmetic Means								Flow-Weighted Means			
	Inflow				Outflow				Total Inflow		Total Outflow	
	G342A	G342B	G342C	G342D	G344A	G344B	G344C	G344D	n	Conc.	n	Conc.
Temperature (°C)	25.4	25.0	25.1	24.9	22.3	22.8	23.5	23.6	-NA-	-NA-	-NA-	-NA-
Dissolved Oxygen (mg/L)	4.7	4.7	5.0	5.3	2.8	3.4	3.0	3.6	-NA-	-NA-	-NA-	-NA-
Specific Conductivity (µmhos/cm)	531	552	557	577	516	491	567	561	-NA-	-NA-	-NA-	-NA-
pH	7.4	7.5	7.5	7.5	7.5	7.6	7.3	7.4	-NA-	-NA-	-NA-	-NA-
Turbidity (NTU)	3.7	2.8	2.8	2.9	2.0	1.5	1.7	1.5	-NA-	-NA-	-NA-	-NA-
Total Dissolved Solids (mg/L)	346	358	360	373	328	319	363	359	61 (104)	324	52 (104)	308
Unionized Ammonia (mg/L)	0.0011	0.0009	0.0009	0.0008	0.0019	0.0014	0.0006	0.0004	57 (100)	0.0014	48 (100)	0.0008
Orthophosphate as P (mg/L)	0.036	0.067	0.096	0.114	0.028	0.044	0.136	0.099	123 (208)	0.134	96 (208)	0.081
Total Dissolved Phosphorus (mg/L)	0.046	0.078	0.107	0.126	0.041	0.058	0.150	0.113	123 (208)	0.147	96 (207)	0.091
Sulfate (mg/L)	8.2	9.2	9.5	10.9	8.3	8.4	6.7	6.8	61 (104)	10.1	52 (104)	5.1
Alkalinity (mg/L)	183	203	210	222	141	141	190	184	61 (104)	165	52 (104)	154
Dissolved Chloride (mg/L)	53	52	47	47	67	62	59	59	61 (104)	45	52 (104)	49
Total Nitrogen (mg/L)	1.48	1.36	1.39	1.38	1.54	1.51	1.51	1.46	60 (103)	1.61	52 (104)	1.33
Total Dissolved Nitrogen (mg/L)	1.30	1.19	1.17	1.15	1.40	1.38	1.40	1.34	61 (104)	1.45	52 (104)	1.22
Nitrate + Nitrite (mg/L)	0.089	0.073	0.063	0.063	0.014	0.017	0.009	0.009	61 (104)	0.125	52 (104)	0.009
Ametryn (µg/L)	0.005	0.005	0.005	0.005	0.017	0.018	0.015	0.014	8 (16)	0.010	6 (16)	0.010
Atrazine (µg/L)	0.114	0.061	0.088	0.056	0.556	0.457	0.261	0.271	8 (16)	0.028	6 (16)	0.028

-NA- : Not Applicable

n: number of samples with flow (total number of samples)

STA-5 DISSOLVED OXYGEN MONITORING

Introduction

STA-5 Administrative Order No. AO-004-EV in Exhibit C of Permit No. 0131842, February 29, 2000, specifies the DO monitoring requirements as STA-1W.

The District developed the following plan to comply with the DO requirements of the Administrative Orders for STA-5. Under the plan, DO concentrations are measured quarterly with Hydrolab™, DataSonde®, or MiniSonde® probes at 30-minute intervals for four consecutive days at the following locations:

- In the discharge canal near structures G-344 and G-344D, to provide representative data whether the discharge is to the Miami Canal, to the RWMA through pump station G-410, or to both sites simultaneously
- On the west bank of the Miami Canal about 100 meters upstream of the confluence of the canal and the STA-5 discharge canal, to measure background conditions in the Miami Canal
- On the west bank of the Miami Canal, about 100 meters downstream of the confluence of the canal and the STA-5 discharge canal, to measure effects of STA-5 discharges to the Miami Canal
- Sites along the north and south transects within the RWMA (Figure 4-29) to measure effects of STA-5 discharges to the RWMA

Sampling Dates

Diel oxygen measurement dates and sites associated with STA-5 for WY2004 are provided in Table 4-11.

Table 4-11. Deployment dates for diel oxygen measurement at STA-5 structures and sites in the Miami Canal.

Event Dates		Structures		Miami Canal Sites	Sites Monitored in Rotenberger Tract	
Start	End	Outflow				
09/02/2003	09/04/2003	STA5DC	G344D	NMC	SMC	-----
12/01/2003	12/04/2003	STA5DC	G344D	NMC	SMC	-----
03/08/2004	03/11/2004	STA5DC	G344D	NMC	SMC	-----

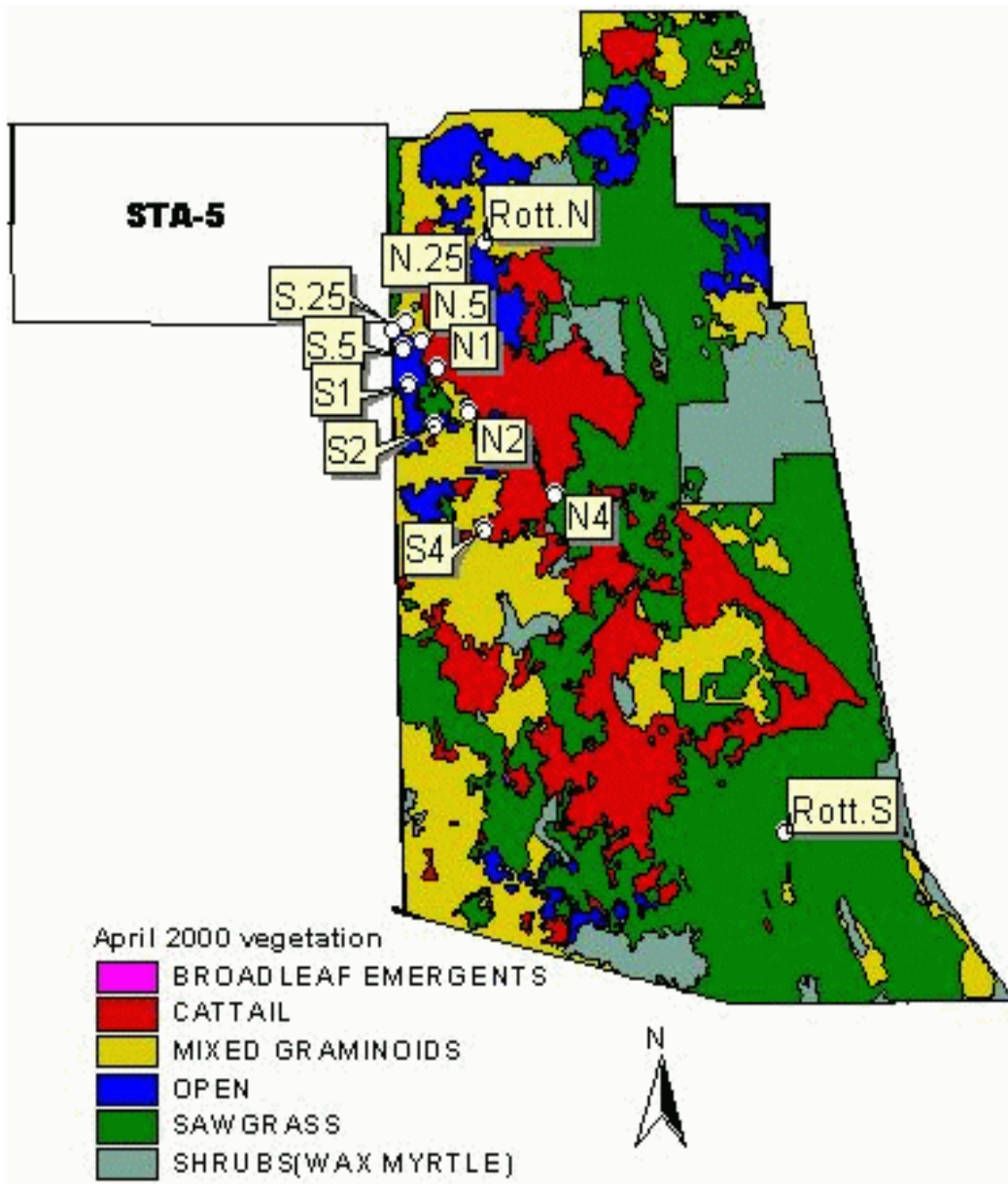

Figure 4-29. DO monitoring sites in the Rotenberger Wildlife Management Area (RWMA).

Comparison of Dissolved Oxygen in STA-5 Discharges with Dissolved Oxygen at Miami Canal Sites

Comparisons of DO in STA-5 discharges with DO in the Miami Canal provide an indication of whether the discharge is affecting the Canal DO concentrations or the diel cycle. The summary statistics for STA-5 discharges and the downstream sites are presented in **Table 4-12**. Examination of this table and **Figure 4-30** shows that DO concentrations at the Miami Canal sites are statistically significantly greater than the DO concentrations in the discharged waters immediately downstream of the discharge structures. The average of the DO concentrations in the discharge canal ranges from 2.31 to 6.38 mg/L in the Miami Canal. Because the discharge canal intersects the Miami Canal between NMC and SMC monitoring sites, the discharged waters may account for the significant difference in DO observed between NMC and SMC sites. The complete data sets collected during WY2004 are presented in Appendix 4-9 in this volume.

STA-5 ENHANCEMENTS

The primary recommended enhancement to STA-5 is the conversion of Cell 2B from emergent macrophyte vegetation to SAV. Additional improvements (**Figure 4-31**) are discussed below.

Modification of G-343 Structures. The G-343 structures are situated in the north-south interior levee subdividing Cells 1A and 2A from Cells 1B and 2B. At present, those structures consist of reinforced concrete box culverts controlled by simple weir crests set at the design static water surface elevation in Cells 1A and 2A. The nature of those structures inhibits the District's ability to control proper flow distribution across the STA. Of greater significance is that the design of those structures limits the District's flexibility in operation of STA-5 in response to significant inflow events. The maximum rate of inflow to STA-5 is limited by water surface elevations in the L-2 borrow canal. As those elevations rise to prescribed levels, structure G-406 is operated to bypass C-139 basin runoff to the L-3 borrow canal. At present, those bypasses continue down the L-3 borrow canal, and are discharged directly to the Everglades Protection Area (WCA-3A) across existing structure G-155 and through the L-3 borrow canal extension. The limited flexibility in operation of the G-343 structures leads to a higher-than-intended frequency and volume of bypass, which in the future can be expected to adversely impact the performance of STA-6. To address these limitations and afford the District increased flexibility in the operation of STA-5, the existing G-343 structures will be modified through the addition of operable gates, and the upstream weir controls will be removed. This modification also requires the addition of telemetric control to the structures, coupled with the addition of stilling wells for water level data acquisition in the upper ends of Cells 1B and 2B. Stilling wells presently exist in Cells 1A and 2A upstream of the G-343 structures. It will also be necessary to extend an overhead power transmission line along the interior levee to service the modified water control structures.

Additional Seepage Control Facilities. In order to minimize the induced loading on STA-5, it is recommended that an additional seepage return pumping station be constructed near the northwest corner of Cell 1B. That station is expected to provide a nominal capacity of 45 cfs, similar to the capacity of existing pumping stations G-349A and G-350A. It also will be desirable to construct an additional canal level control culvert in the northern seepage collection canal.

Removal of Obstructions to Flow. Field observations indicate obstructions to flow exist in Cells 1B and 2B. These are likely a result of relatively high ground elevations, possibly an old road bed in the case of Cell 2B. These will be identified and removed as part of the STA-5 enhancements.

Table 4-12. Statistical summary of diel DO at the outflow stations from STA-5 and stations in the Miami Canal during three deployment periods. No monitoring was done in the RWMA.

Location	Station	Number of Measurements	Mean	Minimum	Median	Maximum	Standard Deviation
Outflow	STA5DC	367	2.45	0.27	2.54	4.18	0.84
	G344D	369	2.17	0.22	2.24	5.57	1.21
Canal	NMC	369	6.81	3.34	7.49	8.25	1.51
	SMC	369	5.95	1.31	6.86	7.85	1.78
Transect N	N.25	----	----	----	----	----	----
	N1	----	----	----	----	----	----
	N4	----	----	----	----	----	----
Transect S	S.25	----	----	----	----	----	----
	S1	----	----	----	----	----	----
	S4	----	----	----	----	----	----

Note: Statistical summaries by event and diel parameter can be found in Appendix 4-4, Table 3.

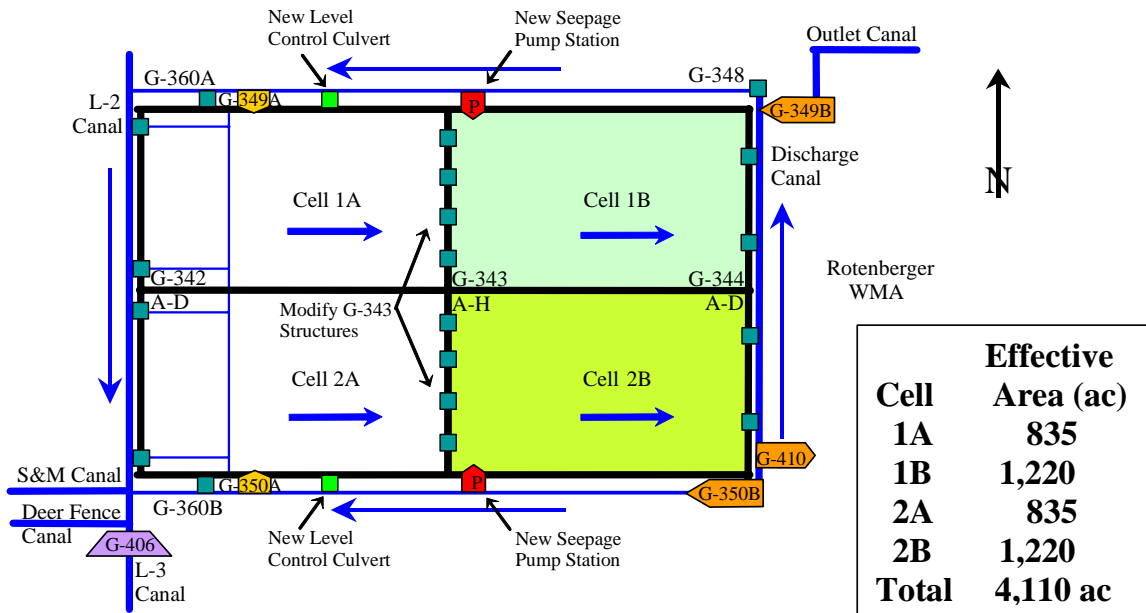

Figure 4-30. DO monitoring sites in the RWMA.

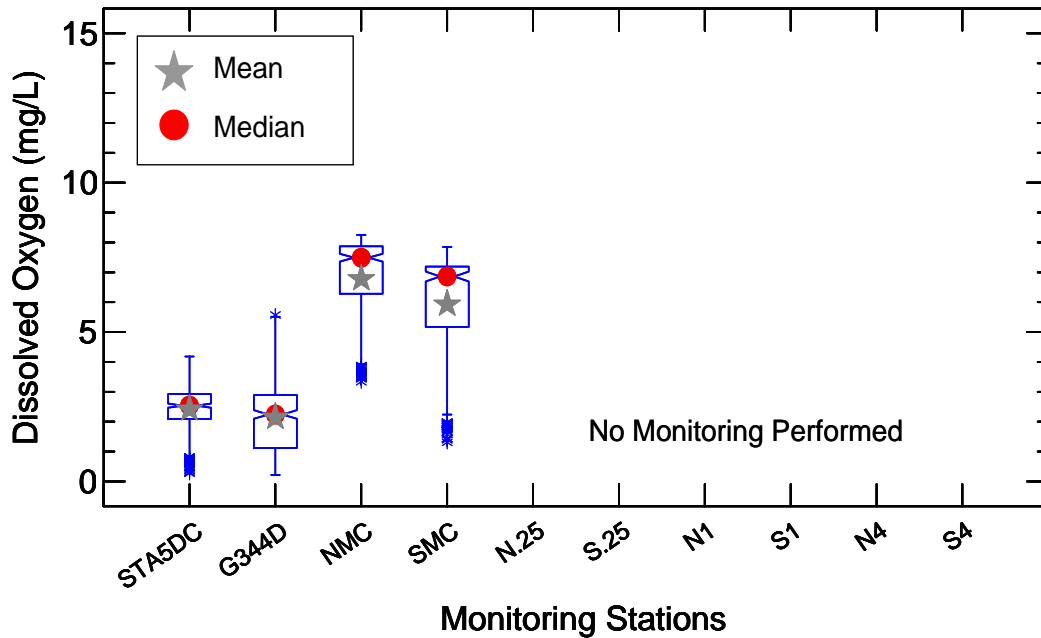

Figure 4-31. Notched box and whisker plots of diel DO measurements at STA-5 outflow stations STA5DC (formally G344A) and G344D and at sites in the Miami Canal north (NMC) and Miami Canal south (SMC) during three monitoring periods. The notch on a box plot represents the approximate (95%) C.I. about the median, which is represented by the narrowest part of the notch. The top and bottom of the box represent the 75th and 25th percentiles, respectively. The whiskers represent the highest and lowest data values that are within two standard deviations of the median. Values above and below the whiskers are greater than two standard deviations from the median. Notches that do not overlap indicate that the data represented by the boxes being compared are significantly different at the 95% C.I.

ROTENBERGER WILDLIFE MANAGEMENT AREA

The Rotenberger Hydropattern Restoration Project is a component of the larger Everglades Construction Project (ECP). The goal of the project is to restore a more natural hydroperiod to slow, alter, and eventually reverse the ecosystem degradation within the Rotenberger Wildlife Management Area (RWMA) caused by drought and seasonal fires, soil oxidation and compaction, and the release of ambient nutrients from soils. Anticipated benefits include the preservation of coverage of the remaining desired vegetative species, the encouragement of desirable wetland vegetation, and the initiation of the process of peat formation. Project features include a 240-cfs electric pump station (G-410) to withdraw treated water from the STA-5 discharge canal for establishing a more natural hydroperiod within the RWMA. This pump station distributes water through a 3.5-mile-long spreader canal located parallel to the west perimeter levee of the RWMA. Discharges out of the RWMA go into the Miami Canal through four gated culverts (G-402A through D) along the eastern boundary of the RWMA. There is a quarter-mile-long collection canal upstream of each outlet structure.

The FDEP issued a modification to the STA-5 EFA permit to include construction and operational authorization for the project in October 2000. This permit established a phased approach to restoration, and recognizes an interagency group including representatives from the FDEP, the Florida Fish and Wildlife Conservation Commission, the USACE, Friends of the Everglades, and the District. The permit requires the interagency group to periodically evaluate the progress the project is making toward achieving its restoration goals.

For WY2004, approximately 16,849 ac-ft were directed into the RWMA through G-410, while approximately 351 ac-ft were discharged to the Miami Canal from the outlet structures (**Figure 4-32**). The flow-weighted mean inflow TP concentration was 45 ppb, yielding a total TP inflow load of about 931 kg (**Figures 4-33 and 4-34**). As the treatment system in STA-5 stabilizes, TP levels entering the RWMA are anticipated to decrease. TP concentrations leaving the RWMA averaged 64 ppb, although the total load was only 28 kg (**Figure 4-35**). However, the majority of this inflow came from Lake Okeechobee and not from STA-5. During January and February 2004, the District requested and received authorization from the FDEP to add supplemental water from Lake Okeechobee to the RWMA. Approximately 11,762 ac-ft were added during this time period. The operation was in association with a regional effort to minimize the drawdown effect of Lake Istokpoga in preparation for a demucking activity. Approximately 732 kg of phosphorus, at a flow-weighted average of 50 ppb, was added to the RWMA as part of this operation. STA-5 contributed approximately 5,087 ac-ft, resulting a flow-weighted mean inflow of 32 ppb and yielding approximately 200 kg for WY2004. This represents a 90-percent reduction in STA-5 discharges compared to the previous year. Beginning in late July 2003, the District began an interim operation of the G-410 inflow pump station, in an attempt to reduce phosphorus loads to the RWMA. A weekly concentration limit of 50 ppb was applied, and while this was effective in reducing phosphorus to the RWMA, it adversely impacted the hydropattern restoration objective of the project by restricting inflow volumes, with the result of not achieving the restoration target depths in this area. This interim operation was terminated prior to the onset of the WY2005 rainy season discharges from STA-5. More information about the operational change and Lake Istokpoga drawdown will be added in the future.

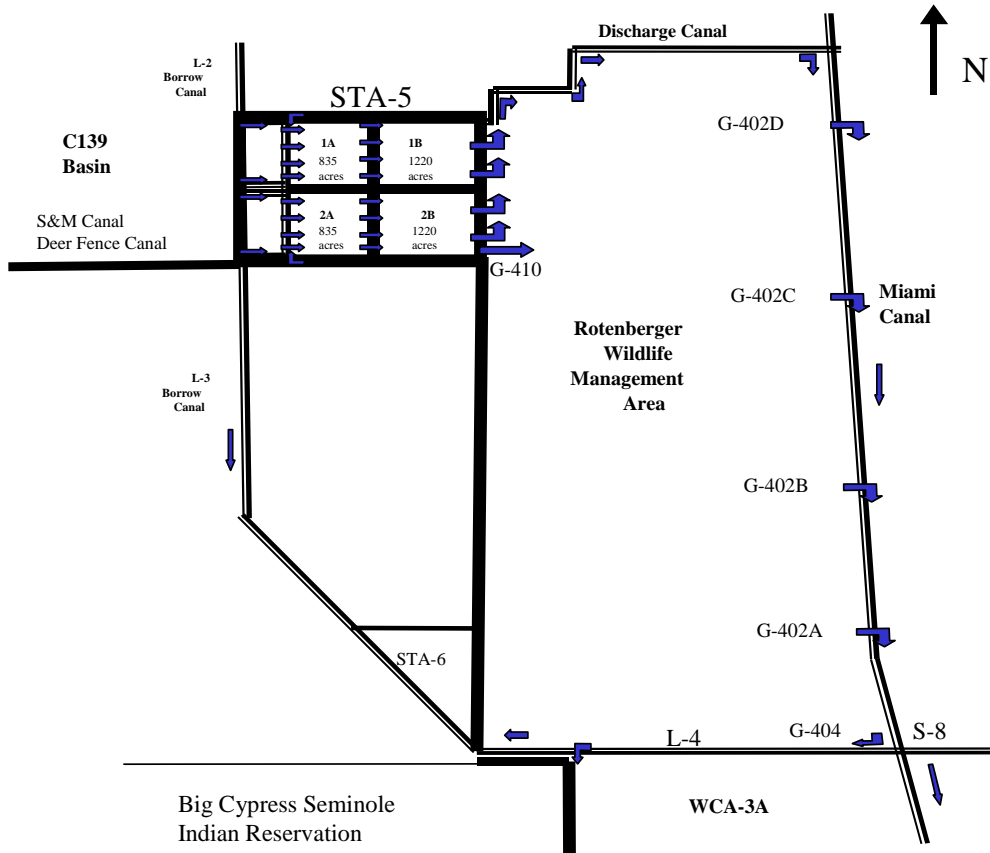

Figure 4-32. Schematic of the RWMA (not to scale).

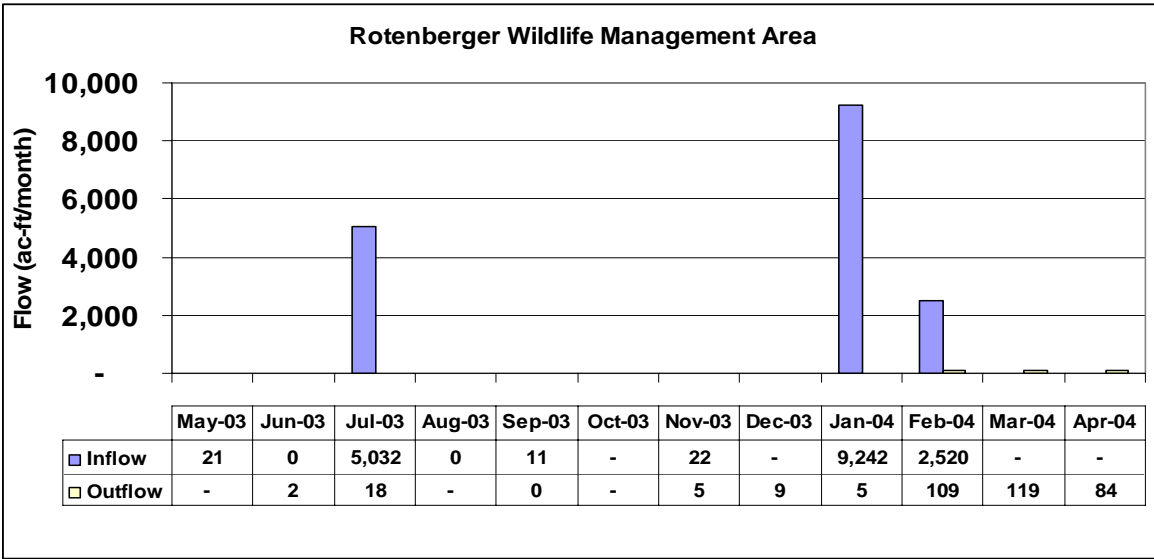

Figure 4-33. Summary of WY2004 flows for the RWMA. (Note: 1 hm³ = 810.7 ac-ft).

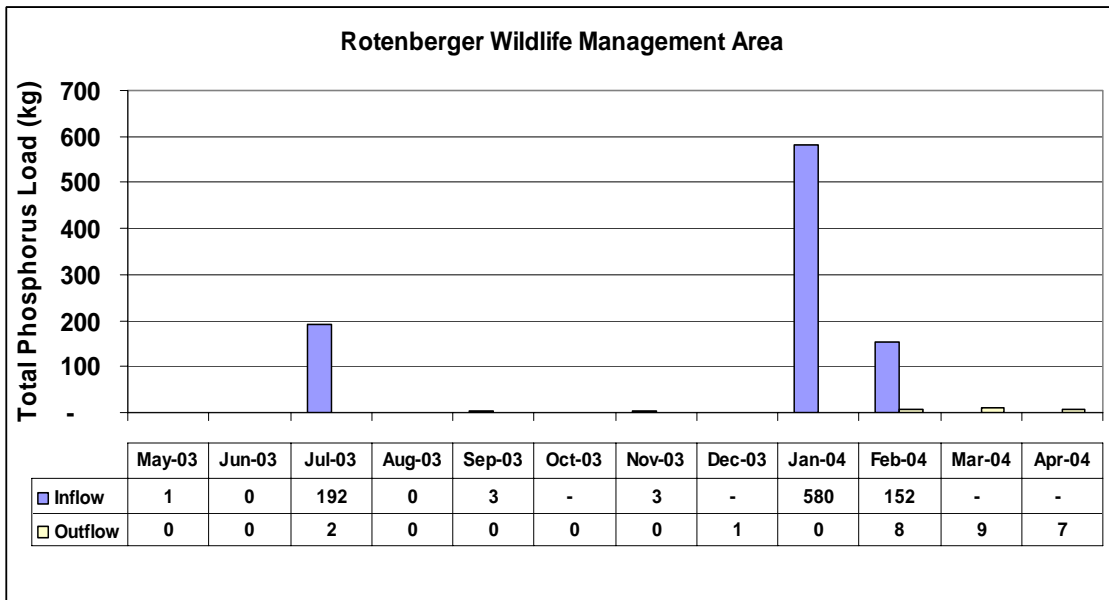

Figure 4-34. Summary of WY2004 TP loads for the RWMA.

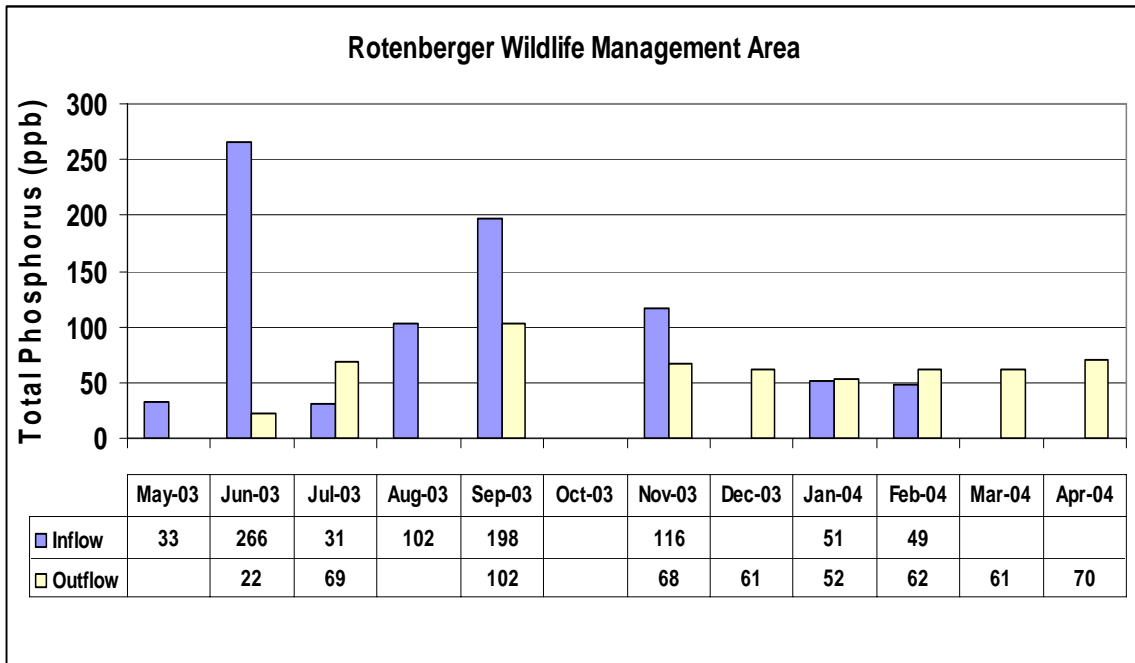

Figure 4-35. Summary of WY2004 TP concentrations for the RWMA.

STA-6 SECTION 1

Stormwater Treatment Area 6 (STA-6) Section 1 contains approximately 870 acres of effective treatment area, arranged in two parallel flow-ways. The northern flow-way (Cell 5) consists of approximately 625 acres of effective treatment area. The southern flow-way (Cell 3) consists of approximately 245 acres of effective treatment area. A schematic of STA-6 is presented in **Figure 4-36**. Based on the simulated 1965–1995 period of flow, the STA should receive a long-term average annual volume of approximately 37,442 ac-ft from the Everglades Agricultural Area (EAA) basin, although annual variability is anticipated. Actual deliveries will vary based on hydrologic conditions in the basins.

Water enters the STA from the G-600 pumping station operated by the U.S. Sugar Corporation, and travels southeast in the supply canal. Water enters the treatment cells through three broad-crested weirs (G-601, G-602, and G-603), flows by gravity east through the treatment cells, and is discharged through several combination box weir/culvert structures (G-393 and G-354). The treated water is then collected in the discharge canal and flows to the L-4 borrow canal, where the majority of the water moves east to the northwest corner of WCA-3A.

STA-6 Section 2 will add about 1,400 acres of additional treatment area to the STA-5/STA-6 system. This expansion will allow for the capture and treatment of runoff from the C-139 annex located just west of the L-3 borrow canal. STA-6 Section 2 is scheduled to be completed by December 31, 2006.

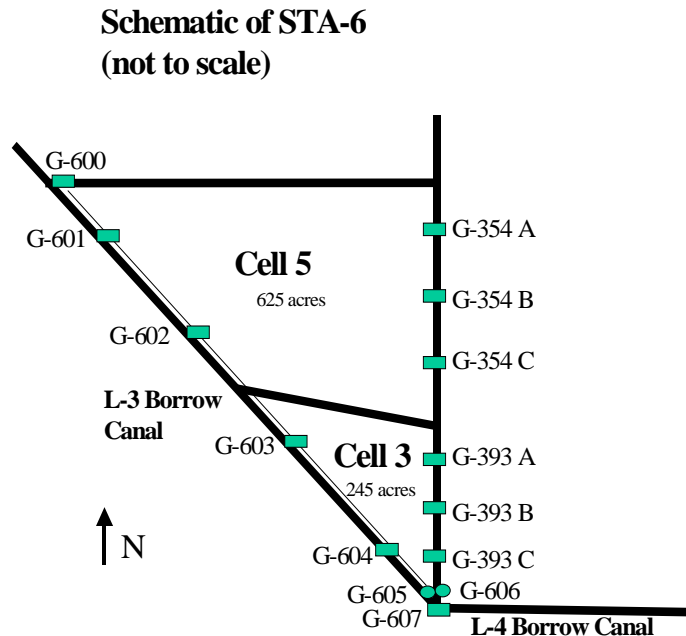

Figure 4-36. Schematic of STA-6 (not to scale).

STA-6 OPERATIONS

During WY2004, approximately 52,674 ac-ft of water were captured by the inflow pump station for STA-6, although there existed some undetermined amount of losses to irrigation water supply, and the net flow into the treatment area was less. The District has recently installed monitoring equipment on the water supply structures. Due to seepage losses, ET, and water supply deliveries from the STA, the net volume of treated water discharged from STA-6 during WY2004 was 35,549 ac-ft. A summary of monthly flow is presented in **Figure 4-37**.

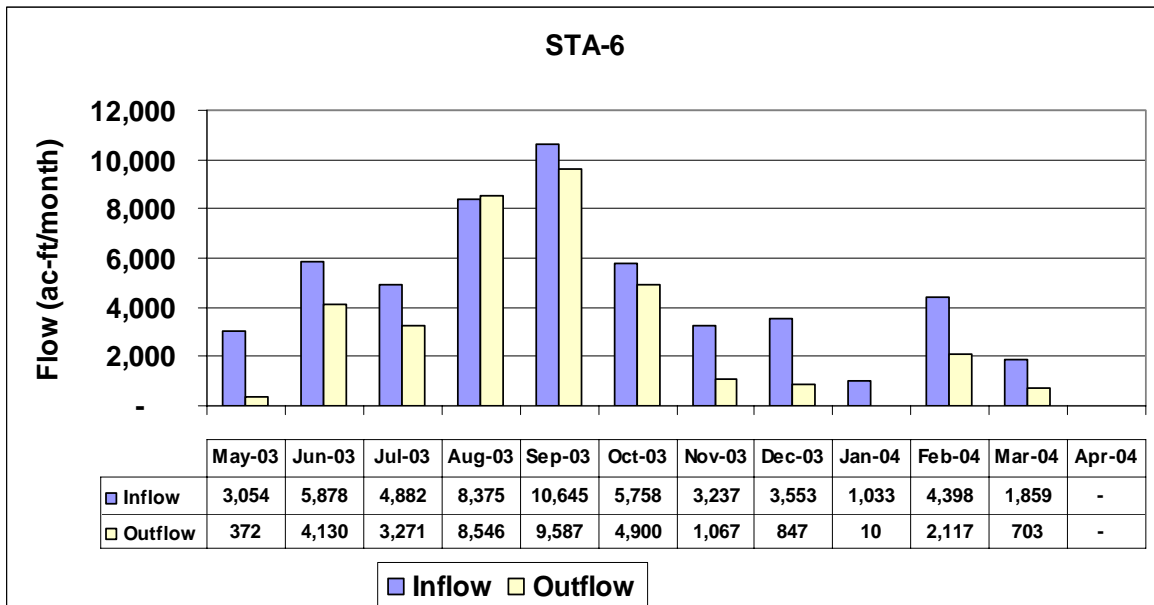

Figure 4-37. Summary of WY2004 flows for STA-6. (Note: 1 hm³ = 810.7 ac-ft).

STA-6 VEGETATION MANAGEMENT

Specific Condition 13(b) of the EFA permit requires that the annual report include information regarding the application of herbicides used to exclude and/or eliminate undesirable vegetation within the treatment cells. For this reporting period, there was no herbicide treatment applied to the marsh area. Vegetation coverage maps from December 2003 are found in Appendix 4-12 of the 2005 SFER – Volume I.

STA-6 SECTION 1 PERMIT WATER QUALITY MONITORING

The District initiated a water quality monitoring program in STA-6 in December 1997 for the purpose of demonstrating compliance with the above referenced conditions of the operating permit. Presently, STA-6 is in a post-stabilization phase. STA-6 discharges do not pose any known danger to the public health, safety, or welfare. Compliance with Specific Conditions 7(a)(i) and 7(a)(ii) was achieved.

STA-6 TOTAL PHOSPHORUS

STA-6 continues to achieve its interim discharge goal of less than 50 ppb for TP. During WY2004, STA-6 received 3.4 mt of TP, equating to a nutrient loading rate of 1.0 g/m². Although STA-6 received greater inflow volume than anticipated during design because the inflow TP concentrations were lower than expected, the actual nutrient loading was about the same as the long-term average anticipated during design. Approximately 2.9 mt of TP were removed by STA-6 during WY2004. During WY2004, STA-6 experienced an 85-percent load reduction in TP (**Figure 4-38**). Furthermore, monthly discharge concentrations were considerably lower than inflow concentrations (**Figure 4-39**). The flow-weighted mean outflow concentration was 12 ppb, well below the EFA permit requirement of 76 ppb. This represents a 78-percent reduction from the inflow concentration of 53 ppb. For informational purposes, the geometric mean TP concentration of the discharge was 13 ppb. The moving 12-month, flow-weighted average outflow decreased from 26 to 12 ppb during the course of WY2004 (see **Figure 4-40**).

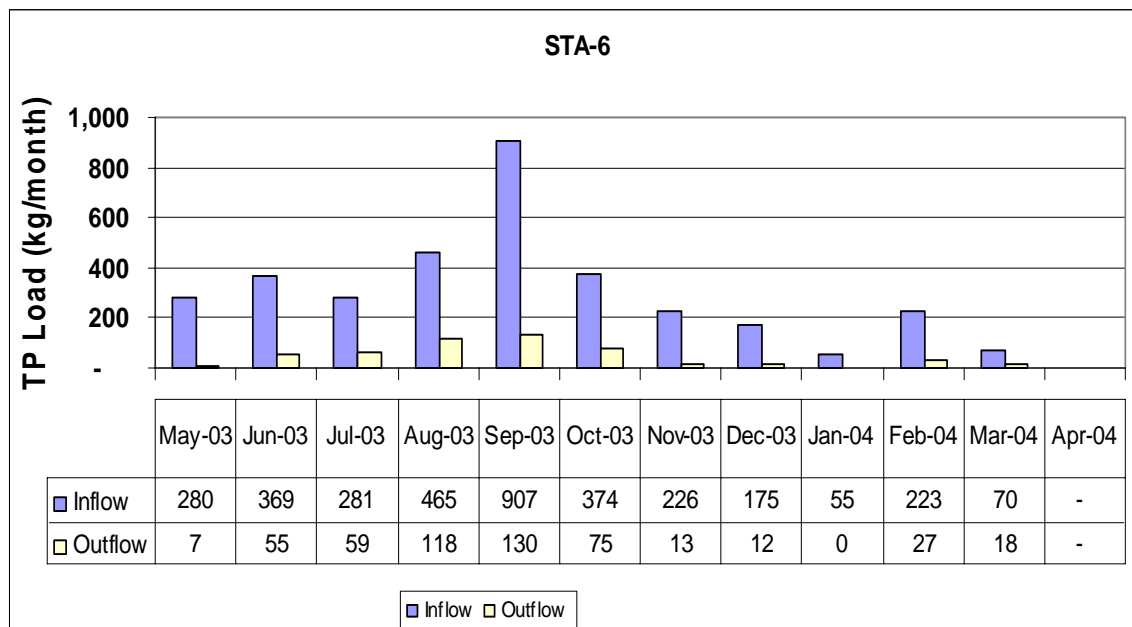

Figure 4-38. Summary of WY2004 TP loads for STA-6.

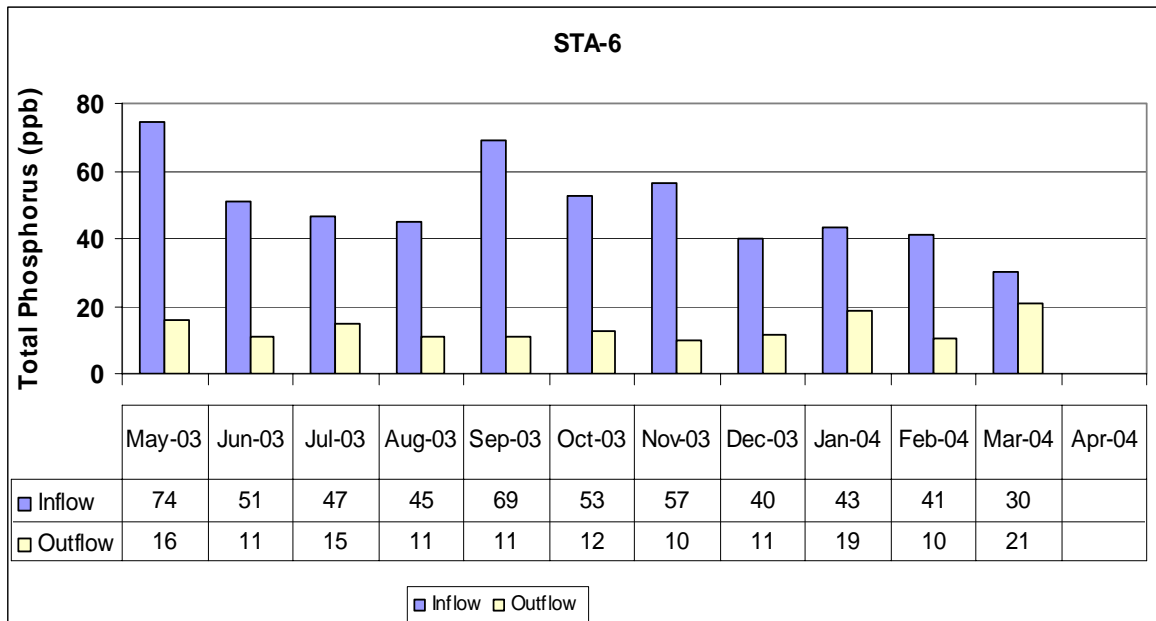

Figure 4-39. Summary of WY2004 TP concentrations for STA-6.

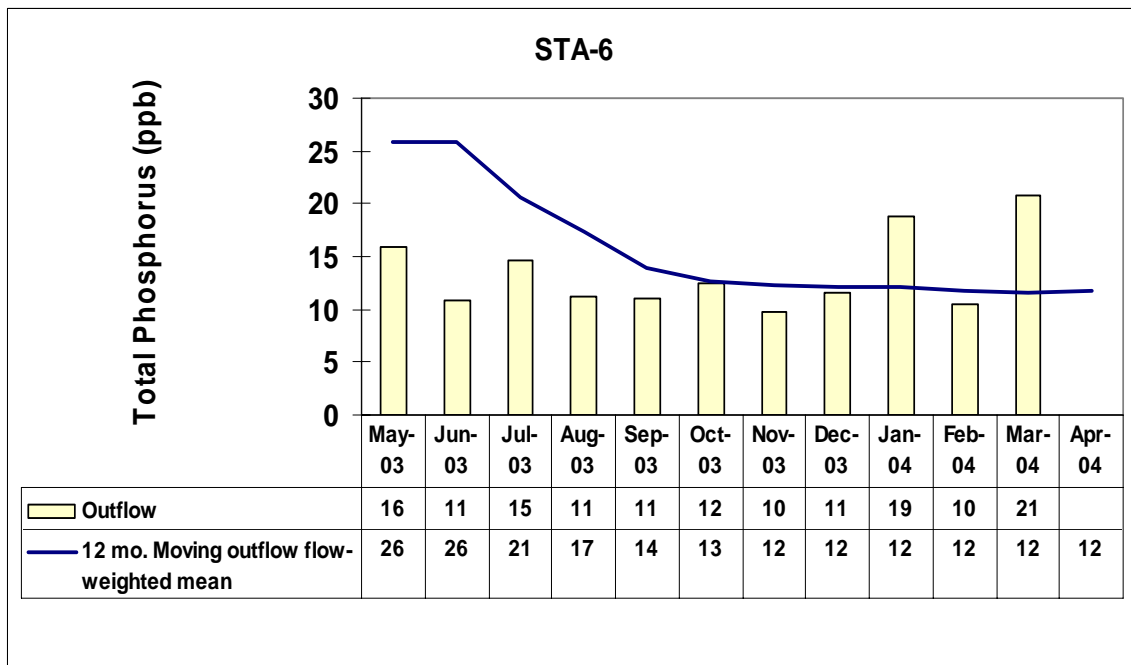

Figure 4-40. Comparison of monthly to 12-month moving average TP concentrations for WY2004 for STA-6 outflow.

STA-6 OTHER WATER QUALITY PARAMETERS

The monitoring data for non-phosphorus parameters at STA-6 during this reporting period are presented in Appendix 4-10 of this volume and are summarized in **Table 4-13**. Compliance with the EFA permit is determined based on the following three-part assessment.

1. If the annual average outflow concentration does not cause or contribute to violations of applicable Class III water quality standards, then STA-6 shall be deemed in compliance.
2. If the annual average concentration at the outflow causes or contributes to violations of applicable Class III water quality standards, but it does not exceed or is equal to the annual average concentration at the inflow stations, then STA-6 shall be deemed in compliance.
3. If the annual average concentration at the outflow causes or contributes to violations of applicable Class III water quality standards, and it also exceeds the annual average concentration at the inflow station, then STA-6 shall be deemed out of compliance.

Annual average concentrations of ametryn and atrazine were detected in both the inflow and outflow at STA-6, but because these parameters have no applicable numeric state water quality standards, discharges from STA-6 are deemed to be in full compliance with the permit (see **Table 4-14**). For STA-6, downstream DO monitoring is not required by the permits. Mercury monitoring results are also discussed in Chapter 2B of the 2005 SFER – Volume I.

The District has included the following documentation to satisfy the remaining monitoring requirements of the EFA permit:

- The District has performed all sampling and analysis under the latest FDEP-approved CompQAP No. 870166G (June 1999).
- A signed copy of this statement is provided in Appendix 4-2 of the 2005 SFER – Volume I.

STA-6 ENHANCEMENTS

Enhancements to STA-6 (**Figure 4-41**) include construction of an interior levee and associated water control structures in Cell 5, as well as conversion of emergent vegetation to SAV in the new downstream cell and construction of STA-6 Section 2.

Table 4-13. Summary of annual arithmetic averages and flow-weighted means for all parameters (other than TP) monitored in STA-6. For the purpose of these comparisons, flow-weighted means are calculated as the quotient of the cumulative product of the mean daily flow and the sample concentration divided by the corresponding cumulative daily flows

Parameter	Arithmetic Means			Flow-Weighted Means			
	Inflow	Outflow		Total Inflow		Total Outflow	
	G600	G354C	G393B	n	Conc.	n	Conc.
Temperature (°C)	25.3	23.6	22.6	-NA-	-NA-	-NA-	-NA-
Dissolved Oxygen (mg/L)	3.7	3.7	2.4	-NA-	-NA-	-NA-	-NA-
Specific Conductivity (µmhos/cm)	868	750	801	-NA-	-NA-	-NA-	-NA-
pH	7.3	7.4	7.3	-NA-	-NA-	-NA-	-NA-
Turbidity (NTU)	3.0	0.8	0.6	-NA-	-NA-	-NA-	-NA-
Color (PCU)	74	68	75	-NA-	-NA-	-NA-	-NA-
Total Suspended Solids (mg/L)	4.7	1.5	1.5	17 (26)	6.0	34 (52)	1.5
Unionized Ammonia (mg/L)	0.0031	0.0009	0.0001	17 (26)	0.0034	34 (52)	0.0004
Total Kjeldahl Nitrogen (mg/L)	1.74	1.56	1.37	17 (26)	1.87	34 (52)	1.40
Orthophosphate as P (mg/L)	0.009	0.003	0.003	38 (52)	0.013	69 (104)	0.004
Total Iron (µg/L)	280	42	48	6 (8)	357	12 (16)	52
Silica (mg/L)	9.29	10.02	8.62	6 (8)	9.62	12 (16)	9.91
Sulfate (mg/L)	24.6	22.4	23.1	6 (8)	26.7	12 (16)	24.3
Alkalinity (mg/L)	290.0	218.5	260.6	17 (26)	288.0	34 (52)	252.5
Dissolved Chloride (mg/L)	90.3	92.3	89.9	17 (26)	85.7	34 (52)	72.8
Dissolved Sodium (mg/L)	63.4	62.9	60.0	6 (8)	60.4	11 (15)	52.4
Dissolved Potassium (mg/L)	4.6	5.2	4.8	6 (8)	4.9	11 (15)	5.2
Dissolved Calcium (mg/L)	109.1	80.7	97.8	17 (26)	111.0	33 (51)	97.8
Dissolved Magnesium (mg/L)	8.9	8.9	8.9	6 (8)	8.7	11 (15)	8.4
Ametryn (µg/L)	0.011	0.017	0.011	3 (4)	0.012	4 (8)	0.016
Atrazine (µg/L)	0.105	0.121	0.042	3 (4)	0.103	4 (8)	0.038

-NA- : Not Applicable

n: number of samples with flow (total number of samples)

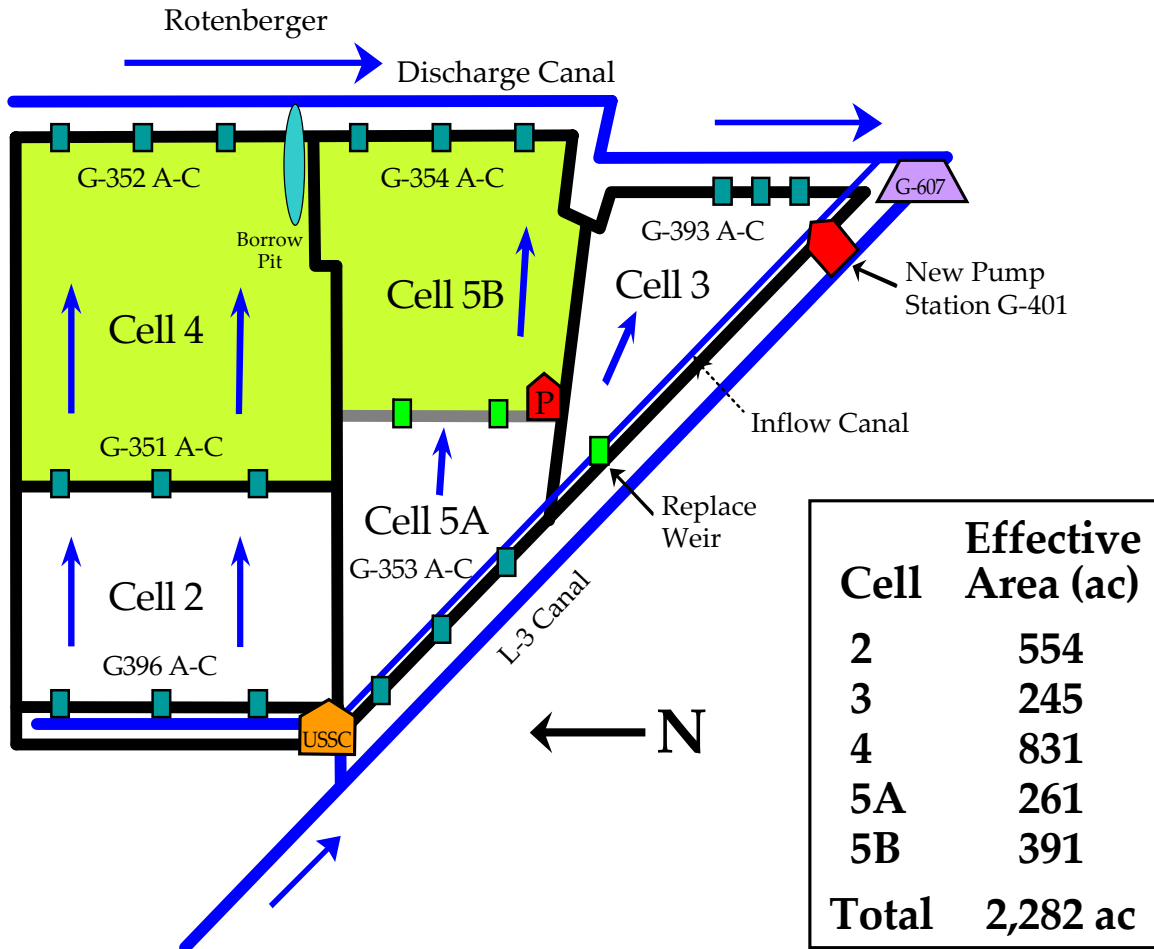

Figure 4-41. STA-6 enhancements (not to scale).

STA PERFORMANCE SYNOPSIS

A brief synopsis of phosphorus removal performance may be insightful since multiple years of STA performance data are available. Performance plots of the STA settling rates (**Figure 4-42**) indicate spatial and temporal variability within and among STAs, with all STAs at or above the design settling rate estimate of 10 m/yr. Time series plots of the load removal (**Figure 4-43**) also show variance between the STAs, as well as annual variability within the STAs. Also evident is the influence of the STA-1W 2003 overload event as well as the response to management activities that began in WY2003. The cumulative load removal for all the STAs combined (**Figure 4-44**) is greater than the 70-percent design assumption. Phosphorus removal appears to be insensitive in STAs with hydraulic residence times (HRTs) greater than 5 days (**Figure 4-45**). Outflow TP concentrations from STAs with low inflow TP concentrations (< 100 ppb) appear to be fairly insensitive to inflow concentrations, suggesting that greater performance can be achieved with improvements due to BMPs in those basins with higher inflow concentrations (i.e., upstream of STA-1W and STA-5). Individual performance time series plots are found in Appendix 4-12 of the 2005 SFER – Volume I.

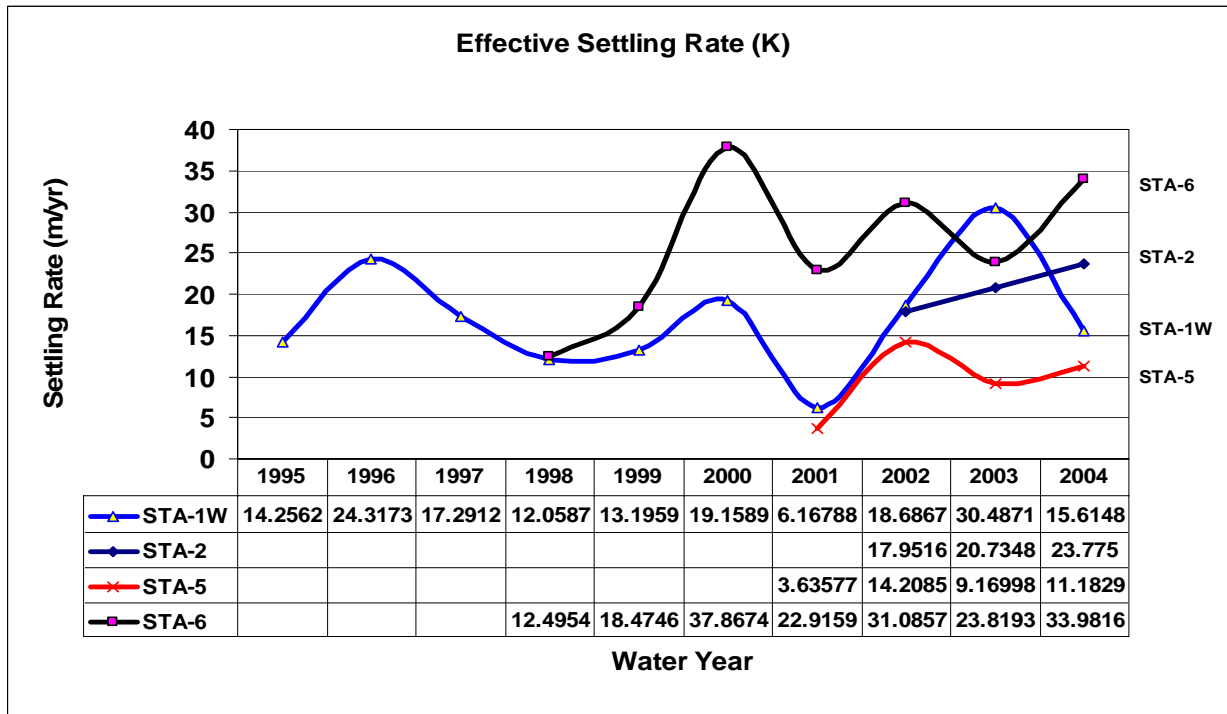

Figure 4-42. Effective settling rates for STA-1W, STA-2, STA-5, and STA-6 for the period of record.

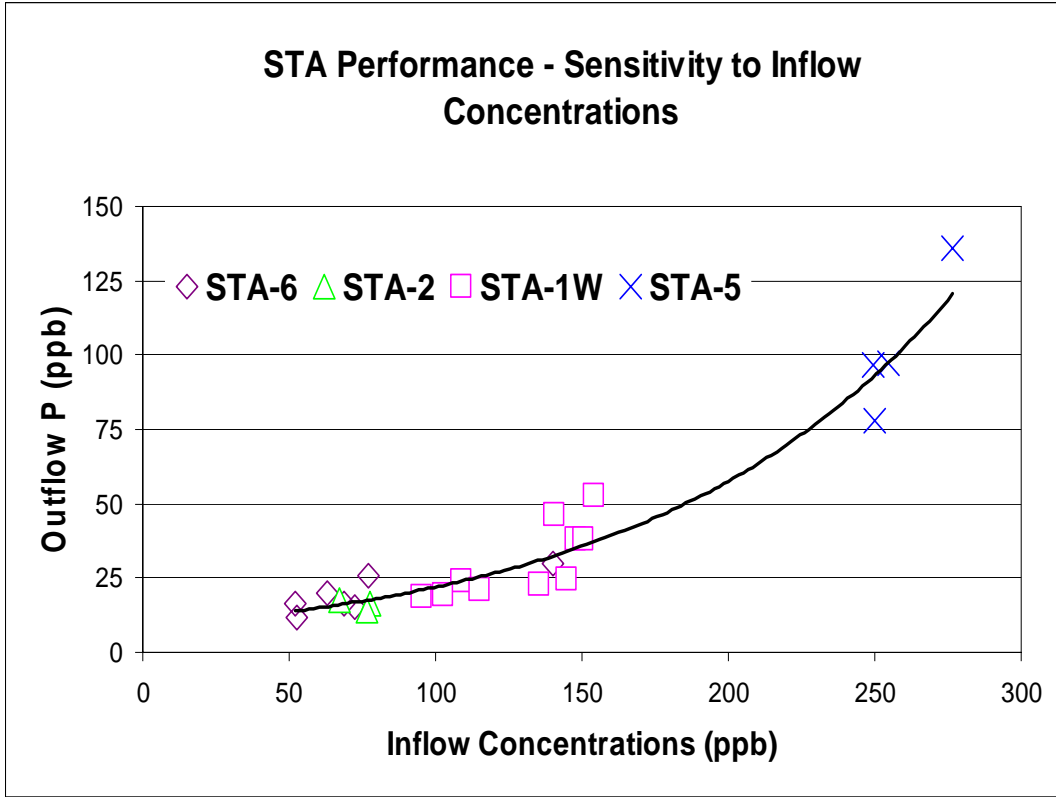

Figure 4-43. STA outflow TP concentration compared to STA inflow concentration.

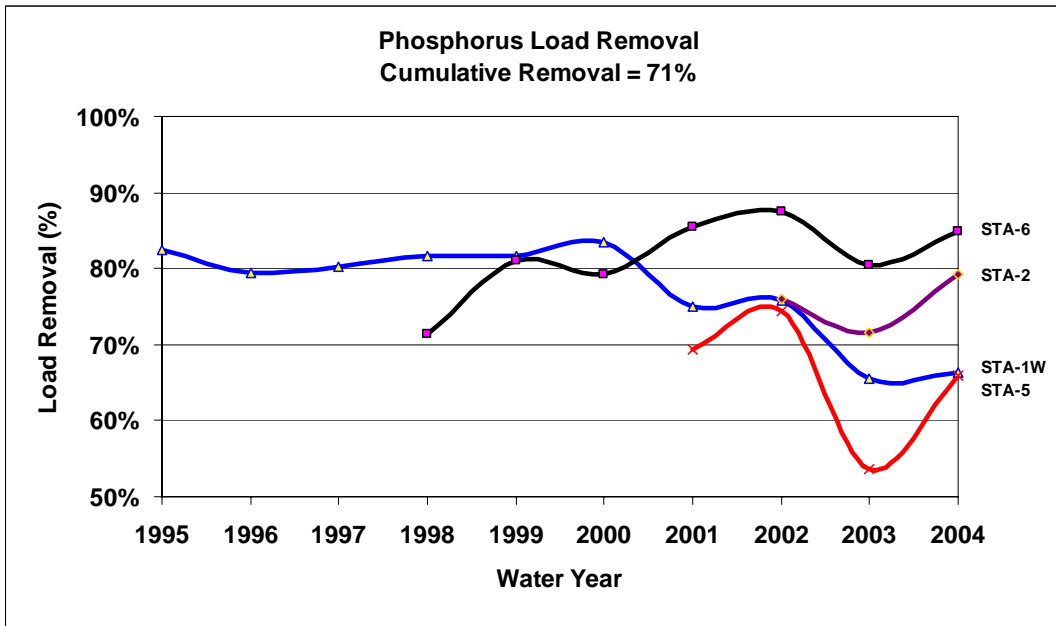

Figure 4-44. STA phosphorus load removal for the period of record.

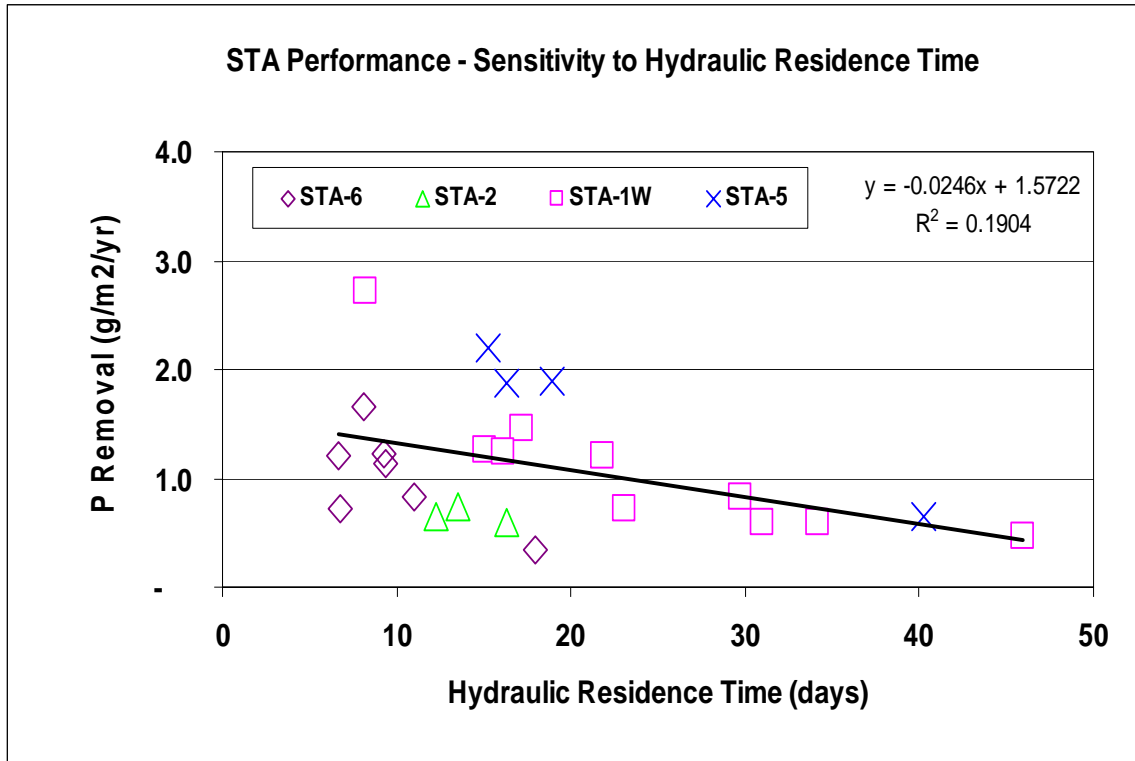

Figure 4-45. Phosphorus removal versus hydraulic residence time for all STAs for the period of record.

STATUS OF OTHER LONG-TERM PLAN PROJECTS

ECP OPERATIONS MONITORING (BC05)

The objective of Project BC05 is to monitor water quality conditions and flow at water control structures that are not covered under existing STA operating permits. Specifically, water quality and flow data will be collected at selected inflow and outflow locations of all treatment cells within the STAs. Many of these structures are currently being monitored, while additional monitoring stations are scheduled to come on-line by FY2006 as outlined in the Long-Term Plan. Flow is monitored on a continuous basis. Water quality samples analyzed for TP are collected weekly; all other parameters are monitored biweekly. These data will be used to assess the performance of each treatment cell and will contribute to the development of strategies for improving TP removal efficiency in the STAs as a whole.

During WY2004, water quality and flow monitoring continued at all existing stations in the STAs and was initiated at the new locations listed in **Table 4-14**. Currently, there is no BC05 associated monitoring in STA-1E or STA-3/4, as these STAs are not operational. Routine BC05 monitoring of both facilities is projected to begin in FY2005. The installation of monitoring stations in STA-3/4 is on schedule, with only the instrumentation of G-374B, G-374E, G-375B, and G-375E (**Figure 4-19**) unfinished. The projected completion date for this work is December 2004. All BC05 monitoring in STA-1W is ongoing, with the exception of the structures in the western flow-way, i.e., Cells 2 and 4 (G-254B, G-254D, G-255, G-256, G-258, and G-309) (**Figure 4-3**). These treatment cells were off-line for most of WY2004. All BC05 monitoring in STA-2, STA-5 and STA-6 is ongoing. The instrumentation of G-337 and G-337A in STA-2 (**Figure 4-11**) is proceeding as scheduled with completion expected by the end of FY2004.

STA SITE MANAGEMENT [BF81]

The District's Operations and Maintenance Division, Environmental Operations Section, currently staffs three STA site managers (one for STA-1W, one for STA-2 and 3/4, and one for STA-5 and STA-6). The primary responsibility of the STA site managers is to coordinate among various departments, divisions, and external stakeholders to facilitate resolution of day-to-day STA management and operation issues. Site managers maintain an onsite presence at STAs to ensure objectives for the STA program are met. Site managers routinely report observations of changing environmental and site conditions, maintenance concerns, or infrastructure problems to appropriate District staff. Additionally, site managers coordinate monthly vegetation management surveys with Vegetation Management and Field Operations staff to identify priorities and strategies to meet overall vegetation goals of the STA program. Site managers also monitor daily stormwater operations and confirm that these operations are consistent with the established STA operation plans.

Table 4-14. Operational status of new and existing flow and water quality monitoring sites at interior treatment cells within the STAs during WY2004.

Location	Description	# Sites	Status
STA-1E (not including groundwater monitoring)	New: None	0	STA not in operation, no monitoring in WY2004
	Existing: None	0	STA not in operation, no monitoring in WY2004
STA-1W	New: G-258 (gate sensor only), G-259	2	Gate sensor installed at G-258. G-259 complete, and all routine monitoring ongoing.
	Existing: G-303, G-305G and N, G-306C and G, G-255, G-254B and D, G-253C and G, G-256, G-308, G-309, G-327A, ENR305, ENR306, G-250S	17	Routine monitoring ongoing in Cells 1, 3, and 5. Water quality sampling platforms installed at G-303, G-308, and G-309. Auto-sampler installation at G-309 is scheduled for completion by end of FY2004.
STA-2	New: None	0	--
	Existing: G-337, G-337A	2	Instrumentation of G-337 and G-337A ongoing.
STA-3/4	New start 5/1/04: G-374B and E, G-375B and E, G-377B and D, G-378B and D, G-370 Seep, G-372 Seep, G-383	11	STA-3/4 is in the start-up phase; routine water quality monitoring has not begun at all sites. Installation of monitoring equipment at G-374 and G-375 is scheduled for completion by December 2004.
	Existing: None	0	--
STA-5	New: None	0	--
	Existing: G-343 (B,C,F,G), G-349A, G-350A	6	All water quality stations on-line and routine monitoring ongoing
STA-6	New: None	0	--
	Existing: G-602, G-603	2	All water quality stations on-line and monitoring ongoing

ACQUISITION OF SURVEY DATA [BC82(1)]

To date, the contractors have completed all surveys planned in STA-1W and STA-2. These surveys have been submitted for District review and should be completed by summer 2005. STA-5 and STA-6 are scheduled for completion by the contractors by summer 2004.

The structures scheduled to be surveyed include:

1. Spillway Structures G-302, G-301, and G-303
2. Culvert Structures G-304A–J, G-306A–J, and G-327A
3. Culvert Structures G-255 and G-305A–V
4. Culvert Structures G-330A–E
5. Culvert Structures G-329A–D
6. Culvert Structures G-331A–G
7. Culvert Structures G-333A–E
8. Spillway Structures G-332 and G-334
9. Pump Stations G-335, G-337, and G-337A
10. STA-5 and STA-6 Structures

ADDITIONAL FLOW AND WATER QUALITY MONITORING STATIONS [BC82(2)]

This project consists of establishing 47 new flow and water quality monitoring stations in the STAs. These additional monitoring efforts focus on STA-3/4 (two seepage pumps and nine culverts) and STA-1W (two culverts) in FY2004 and on STA-1E in FY2005 (19 stations). The instrumentation is completed and flow computation has been implemented at G258 and G259 culverts in STA-1W. The registration in DBHYDRO is not yet complete for G374B and G374E, G375B and G375E, G377B and G377D, G383, and seepage pumps G370 and G372 in STA-3/4, because the instrumentation for these locations has not been completed by the construction contractor. The instrumentation of these sites is part of the construction contract, although currently flow is computed using manual operation logs data provided by the construction contractor from their collections. For culvert flows (G374, G375, G377, G378, and G383), the calibrated equations developed for STA-5 inflow/outflow culverts are used to estimate these flows. The District provides the data to the Regulation Department through spreadsheets. The pump manufacturers' curves are used to develop the flow rating equations at pump stations G370 seep and G372 seep. Water quality monitoring station G258 is in progress and is expected to be completed prior to September 2004. Eleven stations in STA-3/4 scheduled for monitoring installation in FY2005 are still under construction. Telemetry is also being developed to provide real-time monitoring capability.

REVIEW AND CORRECTION OF FLOW MEASUREMENT ANOMALIES [BC82(3)]

The goal of this project is to address flow estimate uncertainties, and to provide good quality flow data at all major flow stations in the STAs. The project was planned to improve the accuracy of flow data at 32 stations for FY2004 and for 48 stations for FY2005. Since the beginning of FY2004, the District has performed 285 flow measurements at STA-1W (65 stations), STA-2 (22 stations), STA-5 (15 stations), and STA-6 (six stations). Rating analyses are completed and implemented at 17 stations in STA-1W (two stations), STA-5 (nine stations) and STA-6 (six stations). Rating analysis is 75 percent complete at 20 stations in STA-1W and is 50 percent complete at 22 stations in STA-2. Due to improvement in the accuracy of flow data, the residuals in the water budget analysis for STA-1W and STA-5 were significantly reduced.

ANALYSIS AND INTERPRETATION [BC82(4)]

One of the major objectives of the Process Development and Engineering component of the Long-Term Plan is to increase our understanding of the underlying mechanisms involved in sequestering phosphorus within constructed wetlands, thereby increasing the probability that treatment performance can be optimized in the STAs. Project BC82(4) will contribute to this goal by developing closed water and TP budgets for each STA treatment cell. The District is monitoring flow and water quality at the inflow and outflow to all the treatment cells under Project BC05. Project BC82(4) is collecting and analyzing vegetation and sediment data to estimate the P mass in stored these compartments. It is our intent to incorporate the change in vegetation and sediment phosphorus storage over time into the calculation of TP budgets.

Developing water and TP budgets for all the treatment cells in the STAs will involve manipulating a very large volume of data collected from many sampling stations. To generate all the individual budgets required for future SFRs and other District needs in a timely fashion¹, the District concluded that it was necessary to automate the numerous data acquisition and computational steps. Thus, the District initiated a contract in FY2004 to develop Microsoft Access programs to calculate treatment cell water budgets for all STAs. The scope of work for this contract is provided in Appendix 4-11 of this volume. The completion date for all programming is October 2004. Once the water budget programs are finalized, a follow-on contract will be created to develop programs that calculate the complimentary TP budget for each treatment cell. The TP budget contract is anticipated to begin no sooner than FY2005.

Accounting for the short-term phosphorus storage by wetland vegetation partly requires estimates of plant areal coverage and nutrient content. Vegetation maps of STA-2, STA-5, and STA-6 based on overflight data acquired in December 2003, and associated coverage measurements for the major vegetation types have been completed (see Appendix 4-12 of this volume)². Vegetation maps for STA-3/4 and STA-1E are scheduled for completion in FY2005. Plant nutrient content (phosphorus and nitrogen) and biomass data were collected under contract for each major vegetation type within all treatment cells during FY2004 (the scope of work for

¹ As originally designed, there was to be a total of 30 treatment cells in the six STAs. The number of treatment cells will increase; correspondingly, the required number of water and TP budgets will also increase, as existing treatment cells are subdivided and additional land is added to the STAs.

² Two versions of the vegetation maps are provided in Appendix 4-12 of this volume. One version shows all the individual vegetation types that were identified in each STA. A second version of each map groups vegetation types into six or seven common categories.

vegetation sampling and analysis is described in Appendix 4-1 of this volume). These data represent baseline vegetation conditions in the STAs. They will be compared against future vegetation coverage and nutrient content data to determine change in phosphorus storage. The District is presently analyzing the variance in the current vegetation data relative to a desired level of sampling error to assist the District in determining the number of samples needed in future collections.

The accretion of nutrients to the sediments constitutes the long-term phosphorus storage mechanism within the STAs. The District has completed the collection and nutrient analysis of sediment and accumulated detrital material (floc) for each cell of STA-1W, 2, 5, and 6 (the scope of work for sediment sampling and analysis is provided in Appendix 4-1 of this volume). Baseline evaluation of the historic peat within STA-3/4 is ongoing, with expected completion by October 2004. The evaluation of sediment within STA-1E is expected to begin by September 2004, with completion by January 2005. These data represent baseline sediment conditions in the STAs. They will be compared against future sediment nutrient content data to determine change in phosphorus storage. The District is presently analyzing the variance in the current sediment data relative to a desired level of sampling error to assist in determining the number of samples needed in future collections.

UPDATE AND MAINTENANCE OF HYDRAULIC MODELS [BC82(5)]

In February 2004, a 23-month work order was issued to Sutron Corporation, Inc., for the performance of two dimensional hydraulic modeling of the STAs. During FY2004, the STA-2 and STA-6 models were developed. For STA-2, an “Existing Conditions” model was first developed using historic data for calibration and verification purposes. An “Enhanced Conditions” model was then developed to simulate the addition of the proposed internal levees and structures in each of the treatment cells. For the STA-2 Existing and Enhanced Conditions models, three flow conditions were simulated: Low Flow, Design Flow, and Peak Flow. For STA-6, an Existing Conditions model was first developed using historical data for STA-6 Section 1 for calibration and verification purposes. An Enhanced Conditions model for STA-6 including Section 2 was then developed. For the STA-6 Section Existing and Enhanced Conditions models, three flow conditions also were simulated: Low Flow, Design Flow, and Peak Flow.

Calibration, model verification and sensitivity analyses were successfully conducted for various flow conditions for STA-2 and STA-6. The Existing and Enhanced Conditions models for both STAs yielded acceptable results for transient and steady state runs resulting in stage values, which were within the design range.

According to the current work order schedule, models will be developed for STA-1E, STA-1W, STA-3/4, and STA-5 in FY2005 and the first three months of FY2006.

PSTA INVESTIGATIONS [BC83(3)] AND PSTA DEMONSTRATION PROJECT IN STA-3/4 [BC83(4)]

Periphyton-Based Stormwater Treatment Area (PSTA), as part of the District’s Advanced Treatment Technology (ATT) Program, is defined as a constructed wetland with a sparse emergent macrophyte community that provides structure to support a dominant periphyton assemblage. PSTA is currently envisioned to be a post-STA technology that is operated at inflow TP concentrations of 50 µg/L (ppb) or less. The primary nutrient removal mechanisms in a PSTA wetland are direct phosphorus uptake by the periphyton and algal-mediated co-precipitation of phosphorus with calcium carbonate. The objective of Project BC83(3) is to track the performance

of the District's ongoing PSTA research projects. During WY2004, the District operated two PSTA research sites: (1) the STA-1W south PSTA test cells, and (2) the PSTA field-scale test facility. The District also initiated construction of a full-scale implementation PSTA project located within Cell 2B of STA-3/4 under Project BC83(4). The status of both projects is discussed below.

STA-1W South PSTA Test Cells

The EFA requires the District to optimize the performance (i.e., nutrient removal capability) of the STAs. To comply with this mandate, the District initiated research projects in the STA-1W test cells to evaluate the efficacy of several different treatment technologies, one of which was PSTA. These projects were part of the District's ATT Program. The STA-1W test cells are a series of thirty 0.2-hectare (0.5-acre) artificial wetlands built to be hydrologically isolated from each other. One set of 15 test cells is located in STA-1W, Cell 1 (north test cells), and the other is in STA-1W, Cell 3 (south test cells). The test cells and the ATT research projects conducted in them are found in Chimney et al. (2000). All work associated with the ATT Program was concluded in January 2002. Results from the ATT projects have been summarized in previous Everglades Consolidated Reports, and final project reports can be found on the District's Website at http://www.sfwmd.gov/erd/ecp/etweb/main_template/report.html.

The District continued monitoring the three south PSTA test cells on a reduced basis after the ATT Program ended to document long-term trends in TP removal in these systems. Two of the south PSTA cells were constructed with 30 cm of shellrock placed over 30 cm of peat (shellrock cells), while the remaining cell had only a peat substrate (peat cell). This section reports on TP removal in the south PSTA test cells for the period from May 1, 2002 through April 30, 2004, which is referred to as the period of extended monitoring.

All the south PSTA test cells were operated at a constant hydraulic loading rate of 2.6 cm/d throughout the period of extended monitoring. In WY2002, water depth averaged 30 cm in all cells; mean depth was doubled to 60 cm in WY2003. Grab samples were collected biweekly at the common inflow to the south test cells and at the outflow from each individual PSTA test cell and analyzed for TP. Means discussed in this section are geometric means. Differences in outflow TP concentrations from the south PSTA test cells were compared using analysis of variance analysis (ANOVA) of \log_{10} -transformed data followed by post hoc mean comparison tests (Tukey-Kramer HSD) using SAS JMP® software, version 5.

During the period of extended monitoring, the mean outflow TP concentration from the peat cell (32 $\mu\text{g/L}$) was not significantly different from the mean inflow TP concentration to all the south PSTA test cells (37 $\mu\text{g/L}$) (**Figure 4-46**). However, both shellrock cells had significantly lower mean outflow TP concentrations (11 $\mu\text{g/L}$ for both shellrock cells) compared to the common inflow and the peat cell. The mean TP outflow concentration from the peat cell in Year 3 (P₆₀: 27 $\mu\text{g/L}$) was significantly lower than in Year 2 (P₃₀: 35 $\mu\text{g/L}$), even though both the mean TP inflow concentration and water depth were higher in Year 3 (**Figure 4-47**). However, neither increased water depth or inflow TP concentration appeared to affect performance of the shellrock cells, where mean TP outflow concentrations (13, 12, 14, and 11 $\mu\text{g/L}$ for Shellrock 1 at 30 cm, Shellrock 1 at 60 cm, Shellrock 2 at 30 cm, and Shellrock 2 at 60 cm, respectively) were not significantly different from each other, but were significantly different from the common inflow. Note that none of the south PSTA test cells achieved a long-term mean outflow TP concentration of 10 $\mu\text{g/L}$, although individual biweekly values were occasionally at or below this concentration threshold.

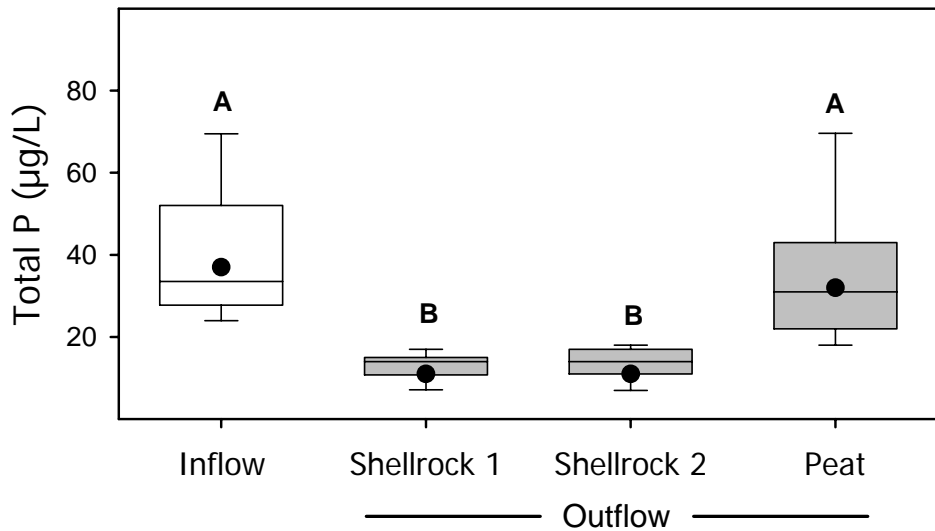

Figure 4-46. Means and box plots of total phosphorus concentrations in the inflow and outflow of the three STA-1W south PSTA test cells for the entire period of extended monitoring (May 1, 2002 through April 30, 2004). Closed circles represent geometric mean concentrations. Top and bottom of box = 75th and 25th percentile of the data distribution, respectively; mid-line in box = 50th percentile; ends of whiskers = 10th and 90th percentiles, respectively. Means with different letters are significantly different from each other ($p < 0.05$).

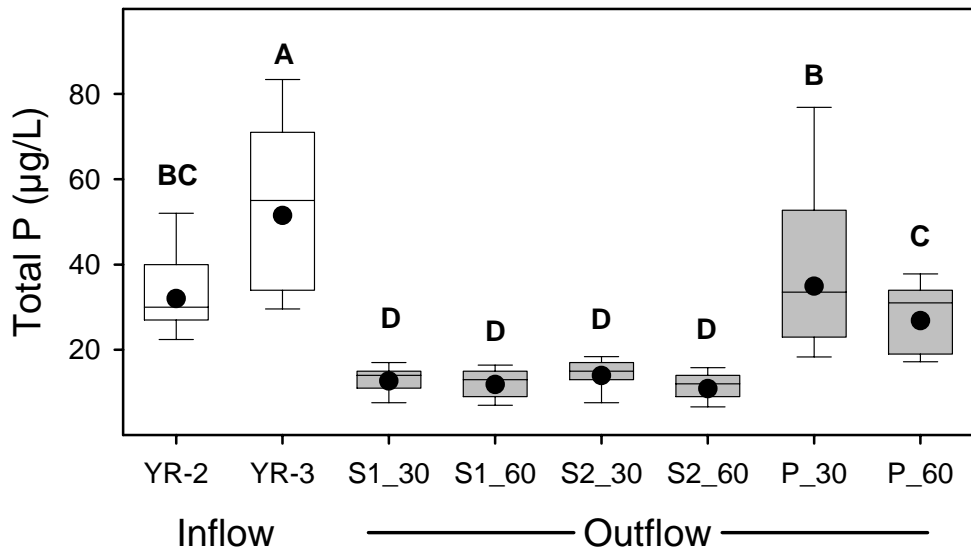

Figure 4-47. Means and box plots of TP concentrations in the inflow and outflow of the three STA-1W south PSTA test cells during Years 2 and 3 of the period of extended monitoring. YR-2 = May 1, 2002 through April 30, 2003; YR-3 = May 1, 2003 through April 30, 2004; S1 and S2 = shellrock cells, P = peat cell; 30 = 30 cm depth, and 60 = 60 cm depth. See text for additional details.

PSTA FIELD-SCALE TEST FACILITY

The PSTA field-scale test facility was a 20-acre site located immediately west of STA-2 that consisted of four 5-acre constructed wetlands. Two of the wetlands had limerock fill placed over the native peat soil (Cells 1 and 2), one wetland had the peat scraped away to expose the underlying bedrock (Cell 3), and the remaining wetland was operated with the peat soil left undisturbed and in place (Cell 4). Cell 2 had internal levees that created a sinusoidal flow-path, effectively increasing water velocity through the system while maintaining the same nutrient mass loading rate as the other three cells. Treatment performance in these wetlands was monitored from November 2001–October 2003. Detailed descriptions of the facility and its operation, and preliminary treatment results can be found in Newman et al. (2003) and Chimney et al. (2004). Decommissioning of the site and the contractor's final project report are presently scheduled for completion by October 2004. This section reports on cell differences in inflow and outflow TP concentrations over the entire operating period of record (POR) from August 5, 2001–October 15, 2003.

The mean TP inflow concentration to the PSTA field-scale test facility during the POR was 22 µg/L, which was not significantly different from the mean outflow concentrations from Cells 1 and 4 (19 and 25 µg/L, respectively; **Figure 4-48**). Conversely, outflow mean TP levels from Cells 2 and 3 (15 and 14 µg/L, respectively) were significantly lower relative to the inflow, but were not significantly different from each other.

STA-3/4 PSTA Demonstration Project

The STA-3/4 PSTA Demonstration Project is listed in Chimney et al. (2004). The project design was completed and accepted by the District in December 2003. The District solicited bids for the construction of the facility under two separate contracts. One contract was for building the levees and all interior water control structures, while a second contract was for fabricating the outflow pump station. Construction of the levees and interior water control structures began in March 2004. Construction of the outflow pump station began in July 2004. All construction phases of the project are scheduled to be completed by January 2005. The project will be flooded at the earliest practical date to begin establishing periphyton and SAV. Experience with other District PSTA and SAV projects indicated that it may take from 6 to 18 months to develop mature plant communities. After periphyton and SAV grow-in is substantially complete, the District will initiate water quality monitoring to compare treatment performance of the PSTA and SAV cells.

OPERATIONAL STRATEGY [BC84(1)]

For the two year period covering January 2002 through March 2004, operational parameters (depth and nutrient loading rate) for STA-2 Cell 3 were evaluated against the outflow phosphorus levels of Cell 3. Inflow concentrations (grab samples) during this period ranged from 12 to 122 ppb, with an arithmetic mean of 41 ppb. Outflow concentrations (grab samples) during this period ranged from 9 to 28 ppb, with an arithmetic mean of 16 ppb. The results of this analysis did not yield any statistically significant guidance which can be employed in the operational decision making process. Possible reasons include the fact that the outflows were at such low levels that performance was relatively insensitive to these operational parameters.

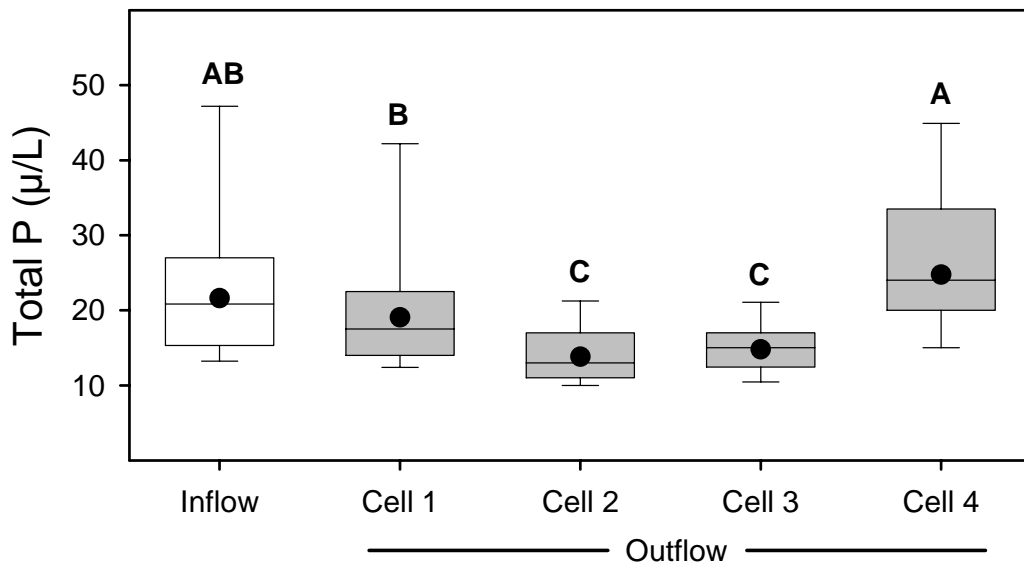

Figure 4-48. Means and box plots of inflow and outflow TP concentrations in PSTA field-scale wetlands for the entire period of record (August 5, 2001 through October 15, 2003). Cell descriptions: Cell 1 - shellrock; Cell 2 - sinusoidal shellrock; Cell 3 - scrap down; and Cell 4 - peat.

VEGETATION MAINTENANCE [BC84(2)]

Refer to STA-specific sections within this chapter for further details on vegetation maintenance associated with the BC84(2) Project.

HYDROLOGIC AND HYDRAULIC ASSESSMENT [BC84(3)] AND INTERNAL MEASUREMENTS [BC84(4)]

The steady-state performance model used in the design of the STAs (Burns & McDonnell, 1993) assumed plug-flow hydraulics. However, tracer studies conducted in Cells 1 and 4 of STA-1W have documented that flow patterns can depart markedly from ideal plug-flow conditions and that large short-circuits may exist (DBEL, 2000; 2003). It is thought that hydraulic inefficiency can reduce TP removal in the STAs (Kadlec, 2000). These non-ideal flow patterns typically will persist until flow is redistributed by some structural means, such as the addition of a levee perpendicular to the direction of flow that subdivides the treatment cell into two smaller areas.

The objective of Project BC84(3) is to conduct tracer studies to characterize the hydraulics (i.e., retention time and flow distribution) of Cell 3 in STA-2 both before and after the construction of an internal levee. The objective of Project BC84(4) is to document the spatial variability of TP concentrations in surface water within Cell 3 based on synoptic grab samples collected during both tracer studies. Work on both projects is being administered through a single contract, which was scheduled to begin July 2004. A final report is due by April 2005. The scope of work for these projects is provided in Appendix 4-13 of this volume.

LITERATURE CITED

- Burns & McDonnell. 1993. Everglades Protection Project, Palm Beach County, Florida. Appendix A to Settlement Agreement, Conceptual Design of Mediated Technical Plan (Draft), November 5, 1993. 92-166-1-002.
- Burns & McDonnell. 2003. Long-Term Plan for Achieving Water Quality Goals, Everglades Protection Area Tributary Basins. Final Report, October 27, 2003.
- Chimney, M., M. Nungesser, J. Newman, K. Pietro, G. Germain, T. Lynch, G. Goforth and M. Moustafa. 2000. Chapter 6: Stormwater Treatment Areas – Status of Research and Monitoring to Optimize Effectiveness of Nutrient Removal and Annual Report on Operational Compliance. G. Redfield, ed. In: *2000 Everglades Consolidation Report*, South Florida Water Management District, West Palm Beach, FL.
- Chimney, M.J., M.K. Nungesser, C. Combs, B. Gu, E. Fogarty-Kellis, J.M. Newman, W. Wagner and L. Wenkert. 2004. Chapter 4B: STA Optimization and Advanced Treatment Technologies. G. Redfield, ed. In: *2004 Everglades Consolidated Report*, South Florida Water Management District, West Palm Beach, FL.
- DBEL. 2000. Submerged Aquatic Vegetation/Limerock Treatment System Technology for Removing Phosphorus from Everglades Agricultural Waters: Follow-on Study - STA-1W Cell 4 Tracer Study. Final report prepared by DB Environmental Laboratories, Inc. for the South Florida Water Management District, West Palm Beach, FL and the Florida Department of Environmental Protection, Tallahassee, FL.
- DBEL. 2003. Assessment of Hydraulic and Ecological Factors Influencing Phosphorus Removal in Stormwater Treatment Area – 1 West. Final Report prepared by DB Environmental Laboratories, Inc. for the Florida Department of Environmental Protection, Tallahassee, FL.
- Goforth, G. 2004. The Operational Design Envelope for the STAs. Draft Technical Report, May 2004. South Florida Water Management District, West Palm Beach, FL.
- Kadlec, R.H. 2000. Failure of the Plug Flow Assumption for ENR Cell 4. Memorandum, August 23, 2000.
- Newman, J.M., G. Goforth, M.J. Chimney, J. Jorge, T. Bechtel, G. Germain, M.K. Nungesser, C. Pathak, D. Rumbold, J. Lopez, L. Fink, B. Gu, K. Cayse, R. Bearzotti, D. Campbell, C. Combs, K. Pietro, N. Iricanin, R. Meeker, G. West and N. Larson. 2003. Chapter 4: Stormwater Treatment Technologies. G. Redfield, ed. In: *2003 Everglades Consolidated Report*, South Florida Water Management District, West Palm Beach, FL.
- Pietro, K. and G. Goforth. 2004. C-51 West Sub-basin Updated Analysis of Flow and Phosphorus Data. Draft Technical Report, June 2004. South Florida Water Management District, West Palm Beach, FL.
- SAS JMP®, Version 5, SAS Institute, Inc., Cary, NC.